



SPARE PARTS LIST

DRIVE UNITS

AME 1600, 967933601, 967933301,
967857801, 2019-09

A AME 1600
DRIVE UNIT

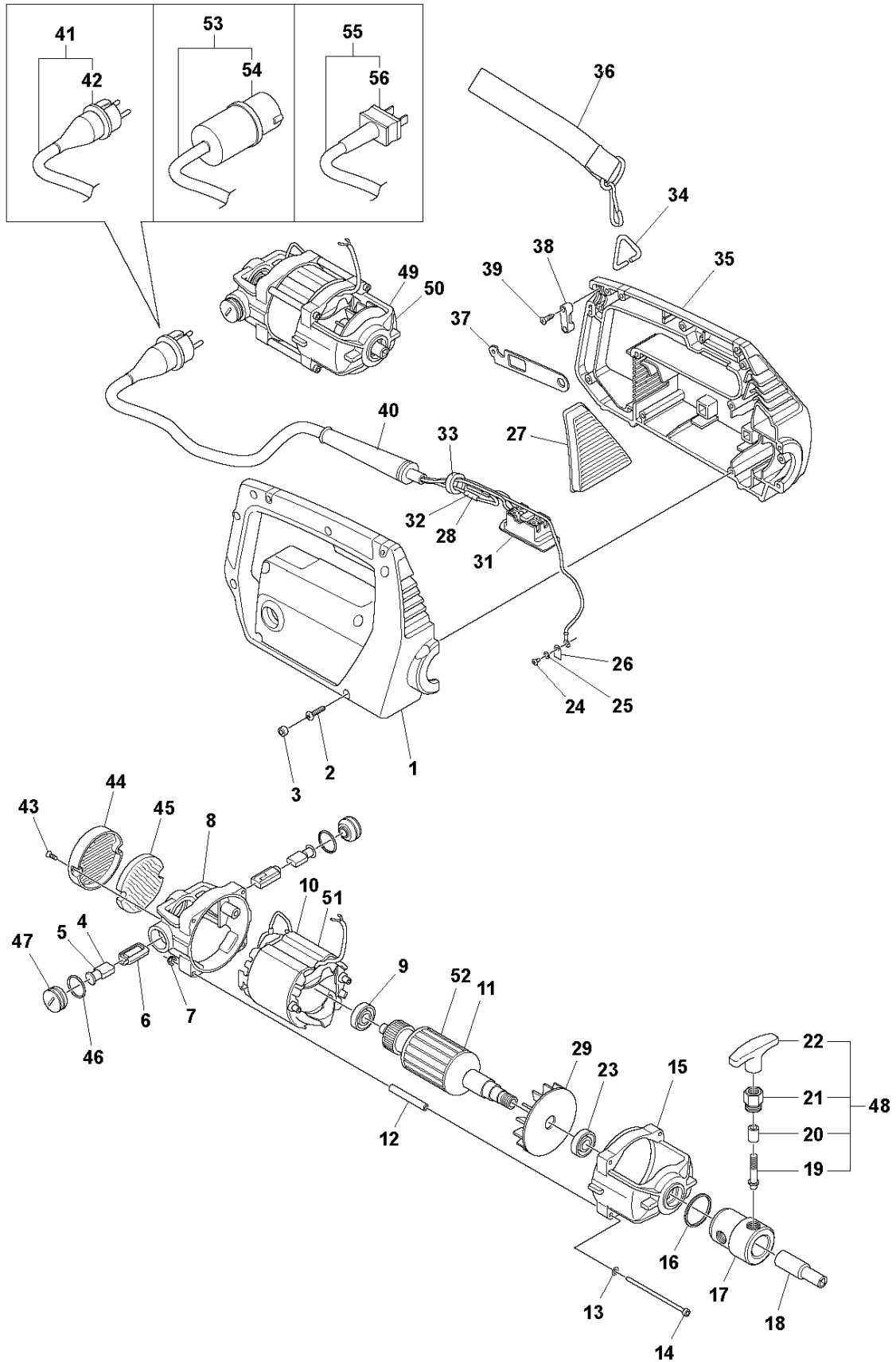

PRODUCT COMPLETE

AME 1600, 967933601, 967933301, 967857801, 2019-09

Ref	Part No	Description	Remark	QTY	KIT
1	595 93 31-01	HOUSING	Left + Right	1	
2	598 44 33-01	SCREW	4.8x22 DIN7981	11	
3	598 76 36-01	SEALING PLUG		11	
4	594 63 41-01	BRUSH	Brush, 230 V	2	49,50
5	594 63 42-01	BRUSH HOLDER	Brush, 115 V	2	49,50
6	594 63 43-01	BRUSH HOLDER		2	49,50
7	595 11 24-01	NUT	M5 DIN 985-8 zn	4	49,50
8	594 63 44-01	FRAME		1	49,50
9	594 86 28-01	BEARING	6201 2Z	1	49,50
10	594 63 45-01	STATOR	Stator, 230 V	1	49
11	594 63 46-01	ROTOR	Rotor, 230 V	1	49
12	595 49 17-01	FRAME		4	49,50
13	594 74 79-01	WASHER		4	49,50
14	598 44 35-01	BOLT	M5x100 ISO4762 8.8	4	49,50
15	595 49 18-01	FRAME		1	49,50
16	598 44 36-01	O-RING	36x2 NBR 70 Shore	1	49,50
17	595 49 19-01	CONNECTOR		1	
18	594 63 47-01	DRIVER		1	49,50
19	594 63 48-01	PLUG		1	48
20	595 49 20-01	SPRING		1	48
21	595 20 44-01	NUT		1	48
22	594 63 49-01	CONNECTION		1	48
23	595 49 21-01	BEARING	6003 2Z	1	
24	598 44 35-02	BOLT	M4x8 ISO1207	1	
25	594 74 79-02	WASHER	4.3 DIN6798A	1	
26	595 20 45-01	PLATE		1	
27	595 49 22-01	COVER		1	
28	594 63 51-01	PROTECTION	Thermal protector, 230 V	1	
29	595 49 38-01	FAN		1	49,50
31	594 63 50-01	SWITCH	Switch + capacitors	1	
32	598 44 50-01	HEAT PROTECTOR	Thermal protector, 115 V	1	
33	595 52 59-01	HOLDER		1	
34	595 20 47-01	RING		2	
35	598 44 36-03	O-RING		1	
36	595 20 48-01	BELT		1	
37	595 49 24-01	CABLE		1	
38	595 49 25-01	CABLE		1	
39	598 44 33-02	SCREW	3.9x22 DIN7982	2	
40	595 20 49-01	CABLE		1	
41	595 20 50-01	PLUG	Cable + plug, 230 V	1	
42	595 20 51-01	PLUG	SCHUKO TYPE 2P 16A	1	
43	598 44 33-03	SCREW	3.5x16 DIN 7981	2	49,50
44	595 49 28-01	COVER		1	49,50
45	594 63 52-01	AIR FILTER		1	49,50
46	598 44 36-02	O-RING	23x2 NBR 70 Shore	2	49,50
47	594 63 53-01	BRUSH		2	49,50
48	594 63 54-01	CONNECTION		1	
49	594 63 55-01	MOTOR	Motor set 230 V	1	
50	595 49 29-01	MOTOR	Motor set 115 V	1	
51	595 20 43-01	STATOR	Stator, 115 V	1	50
52	595 49 16-01	ROTOR	Rotor, 115 V	1	50
53	595 49 26-01	CABLE	Cable + plug, 115 V, UK	1	
54	595 49 27-01	PLUG	2P+T 100/130V 16A 115 V UK	1	
55	598 76 37-01	CABLE	Cable + plug, 115 V, US	1	
56	598 76 38-01	PLUG	125V 15A NEMA 5-15 115 V USA	1	

B AME 1600
DECALS

1

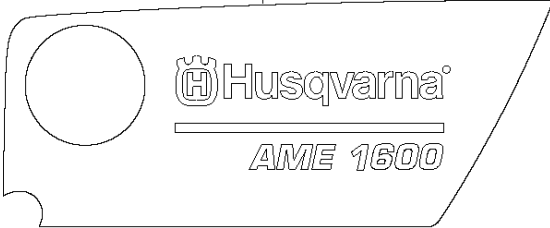

2



3

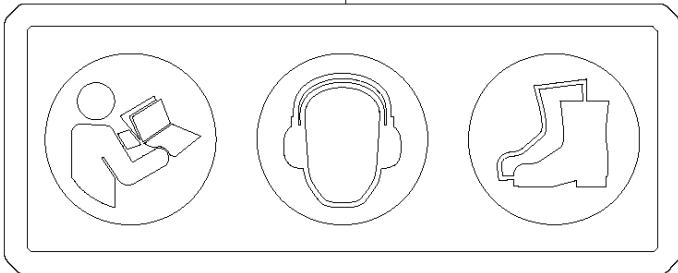

DECALS

AME 1600, 967933601, 967933301, 967857801, 2019-09

Ref	Part No	Description	Remark	QTY KIT
1	598 44 47-03	STICKER	Husqvarna & Model decal - right side	1
2	598 44 47-04	STICKER	Husqvarna & Model decal - left side	1
3	598 44 47-02	STICKER	Safety	1