

Operator's manual

K3600 MKII

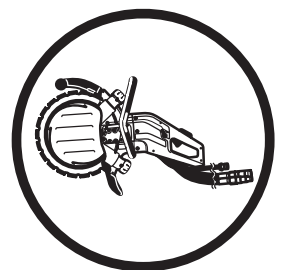

Please read the operator's manual carefully and make sure you understand the instructions before using the machine.

English

KEY TO SYMBOLS

Key to symbols

WARNING! The machine can be a dangerous tool if used incorrectly or carelessly, which can cause serious or fatal injury to the operator or others.



Please read the operator's manual carefully and make sure you understand the instructions before using the machine.



Always wear:

- Approved protective helmet
- Approved hearing protection
- Protective goggles or a visor
- **Breathing mask**



This product is in accordance with applicable EC directives.



Other symbols/decals on the machine refer to special certification requirements for certain markets.

Always disconnect the machine from the hydraulic hoses before inspection and/or maintenance of the machine.

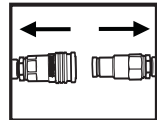

Always wear approved protective gloves.

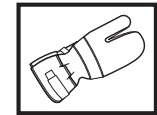

Regular cleaning is required.

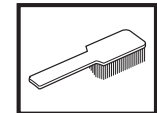

Visual check.



Protective goggles or a visor must be worn.



CONTENTS

Contents

KEY TO SYMBOLS

Key to symbols 2

CONTENTS

Contents 3

WHAT IS WHAT?

What is what on the power cutter? 4

SAFETY INSTRUCTIONS

Steps before using a new power cutter. 5

Personal protective equipment 5

Machine's safety equipment 5

Checking, maintaining and servicing the machine's
safety equipment 6

General safety precautions 7

General working instructions 7

SETTINGS AND ADJUSTMENTS

Drive 11

Fitting the blade 11

Hydraulic hoses 13

Water hose 13

Water supply 13

Water dosage 13

STARTING AND STOPPING

Starting and stopping 14

MAINTENANCE

Maintenance 15

Dismantling the complete guide roller 15

Assembling the complete guide roller 15

Drive wheel 16

Replacing the support rollers/guide rollers 16

Reconstructing the blade 17

Couplings 17

Hydraulic hoses 17

Maintenance schedule 18

Blades conforming to EN13236 18

TROUBLE SHOOTING

Mechanics 19

TECHNICAL DATA

Extending the hydraulic hoses 20

EC-declaration of conformity 21

WHAT IS WHAT?

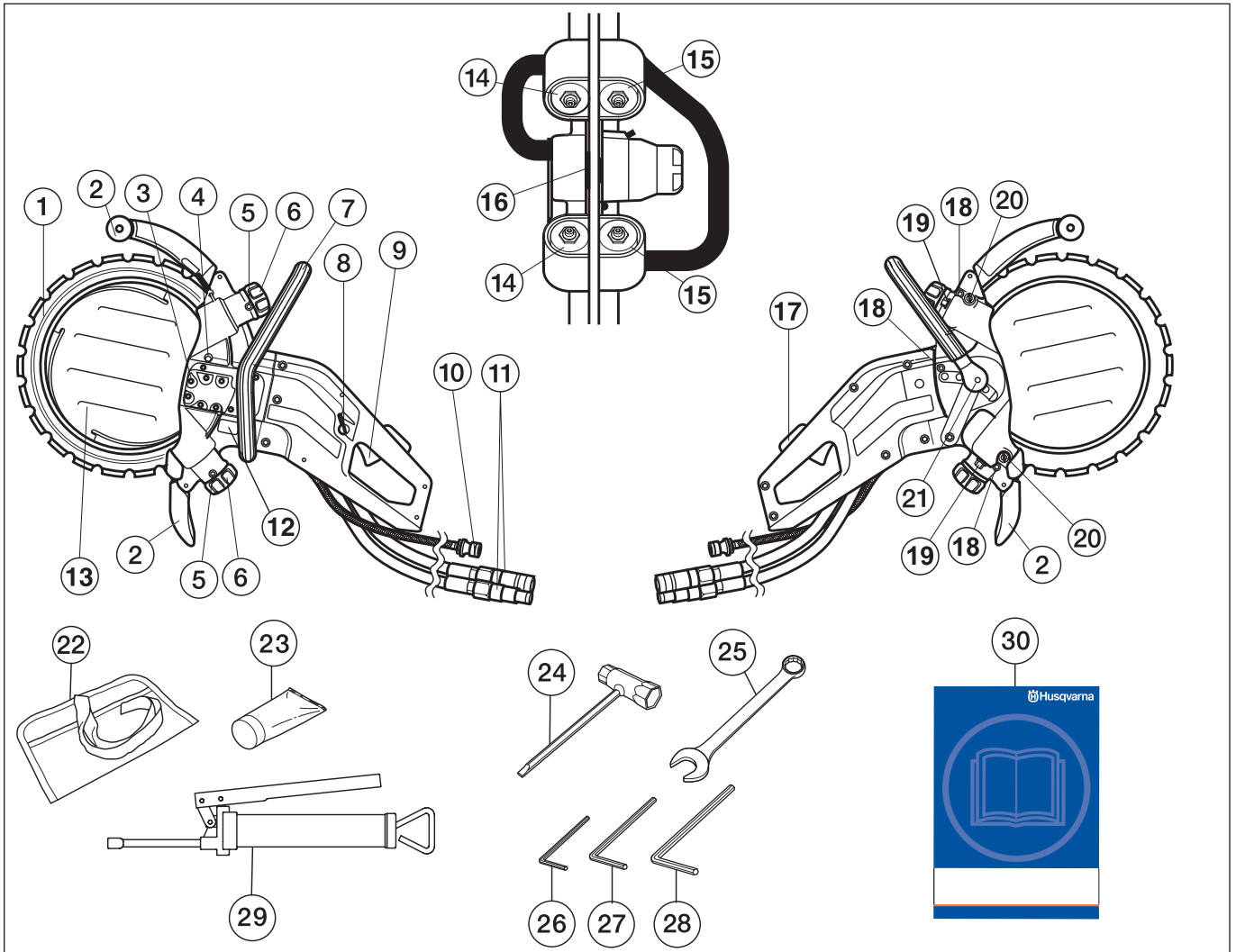

What is what on the power cutter?

- | | |
|--------------------------------------|---|
| 1 Diamond blade | 16 Drive wheel |
| 2 Blade guard/spray guard | 17 Switch lock and ON/OFF valve for the water |
| 3 Hydraulic motor | 18 Cover screws |
| 4 Locking button for the drive wheel | 19 Locking nuts for the support rollers |
| 5 Grease nipples | 20 Adjuster screws |
| 6 Control for the guide rollers | 21 Switch lock for the front handle |
| 7 Front handle (adjustable) | 22 Tool bag |
| 8 Water adjustment control | 23 Bearing grease |
| 9 Switch | 24 Combination spanner |
| 10 Water connector | 25 19 mm combination spanner |
| 11 Couplings for hydraulic hoses | 26 4 mm hex key |
| 12 Rating plate | 27 5 mm hex key |
| 13 Water disc | 28 6 mm hex key |
| 14 Support rollers | 29 Grease gun |
| 15 Guide rollers | 30 Operator's manual |

SAFETY INSTRUCTIONS

Steps before using a new power cutter.

- This machine is a hydraulically operated power cutter intended for free-hand cutting. The machine should be connected to a hydraulic unit with an oil flow of 35-42 litres/min and a maximum pressure of 150 bar.
- Please read the operator's manual carefully.
- Check the cutting blade's mounting, see the chapter "Assembly".

Let your **Husqvarna** dealer check the power cutter and make essential adjustments and repairs.



WARNING! Under no circumstances may the design of the machine be modified without the permission of the manufacturer. Always use genuine accessories. Non-authorized modifications and/or accessories can result in serious personal injury or the death of the operator or others.



WARNING! Use of products which cut, grind, drill, sand or shape material can generate dust and vapors which may contain harmful chemicals. Know the nature of the material being worked on and wear appropriate dust mask or respirator protection.



WARNING! A power cutter is a dangerous tool if used carelessly or incorrectly and can cause serious, even fatal injuries. It is extremely important that you read and understand the contents of this Operator's Manual.

Husqvarna Construction Products has a policy of continuous product development. Husqvarna reserves the right to modify the design and appearance of products without prior notice and without further obligation introduce design modifications.

All information and all data in the Operator's Manual were applicable at the time the Operator's Manual was sent to print.

Personal protective equipment



WARNING! You must use approved personal protective equipment whenever you use the machine. Personal protective equipment cannot eliminate the risk of injury but it will reduce the degree of injury if an accident does happen. Ask your dealer for help in choosing the right equipment.

- Protective helmet
- Hearing protection
- Protective goggles or a visor



- Breathing mask

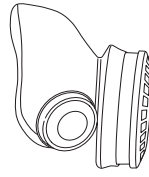

- Heavy-duty, firm grip gloves.

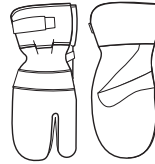

- Tight-fitting, heavy-duty and comfortable clothing that permits full freedom of movement.



- Use leg-guards recommended for the material to be cut.
- Boots with steel toe-caps and non-slip sole



- Always have a first aid kit nearby.



Machine's safety equipment

This section describes the machine's safety equipment, its purpose, and how checks and maintenance should be carried out to ensure that it operates correctly. See the "What is what?" section to locate where this equipment is positioned on your machine.



WARNING! Never use a machine that has faulty safety equipment! Carry out the inspection, maintenance and service routines listed in this section.

Switch

The switch is used to start and stop the machine.

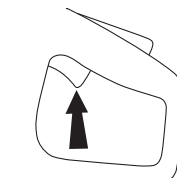

SAFETY INSTRUCTIONS

Switch lock and ON/OFF valve for the water

The switch lock is designed to prevent accidental operation of the switch. The ON/OFF valve for the water supply is also controlled with the switch lock.

When the switch lock (A) is pressed in this opens the water valve and releases the switch (B).

As long as the switch is pressed in the switch lock remains pressed in and the water valve open.

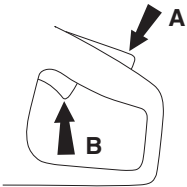

When you release your grip on the handle this resets both the switch and the switch lock. This takes place via two independent return spring systems. This position causes the machine to stop and the switch to be locked.

The water valve returns to the stop position when the handle is released.

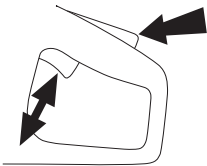

Blade guard

This guard is fitted above the blade and is designed to prevent parts of the blade or cutting fragments from being thrown towards the user.

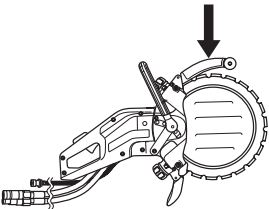

Checking, maintaining and servicing the machine's safety equipment



WARNING! All servicing and repair work on the machine requires special training. This is especially true of the machine's safety equipment. If your machine fails any of the checks described below you must contact your service agent. When you buy any of our products we guarantee the availability of professional repairs and service. If the retailer who sells your machine is not a servicing dealer, ask him for the address of your nearest service agent.

Checking the starting and stopping functions of the switch

Start the machine, release the switch, and check that the machine and blade stop.

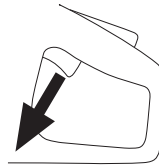

Checking the switch lock

Check that the switch is locked when the switch lock is in its home position.

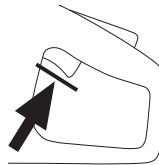

Press the switch lock and check that it returns to its home position when released.

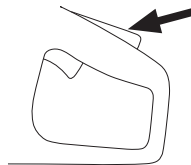

Check that the switch and switch lock move freely and that their return spring systems function.

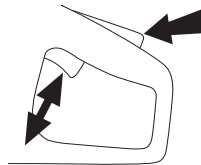

Start the machine, release the switch, and check that the machine and blade stop.

SAFETY INSTRUCTIONS

Checking the blade guard



WARNING! Always check that the guard is correctly fitted before starting the machine. Also check that the blade is fitted correctly and is not damaged in anyway. A damaged blade can cause personal injuries. See instructions under the heading Assembly.

Check that the guard is complete and without any cracks or deformations.

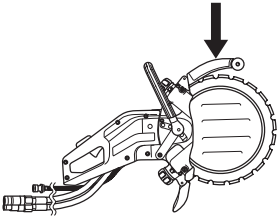

General safety precautions

- A power cutter is designed to cut hard materials, such as masonry. Observe the increased risk of kickback when cutting soft materials. See instructions under the heading How to avoid kickback.
- Do not use the power cutter until you have read the entire contents of this Operator's Manual. All servicing, in addition to the points listed in the section "Control, maintenance and service of the power cutter's safety equipment", should be carried out by trained service specialists.
- Never use the machine if you are tired, if you have drunk alcohol, or if you are taking medication that could affect your vision, your judgement or your co-ordination.
- Wear personal protective equipment. See instructions under the heading Personal protective equipment.
- Never use a machine that has been modified in any way from its original specification.
- Never use a machine that is faulty. Carry out the checks, maintenance and service instructions described in this manual. Some maintenance and service measures must be carried out by trained and qualified specialists. See instructions under the heading Maintenance.
- Never allow anyone else to use the machine without first ensuring that they have understood the contents of the operator's manual.

Transport and storage

Do not store or transport the power cutter with the blade fitted.

Store the power cutter in a lockable area so that it is out of reach of children and unauthorised persons.

The blade should be removed from the machine after use and stored well. Store the blade in the dry.

General working instructions



WARNING! This section describes basic safety directions for using a power cutter. This information is never a substitute for professional skills and experience. If you get into a situation where you feel unsafe, stop and seek expert advice. Contact your dealer, service agent or an experienced power cutter user. Do not attempt any task that you feel unsure of!

Basic safety rules

- Look around you:
 - To ensure that people, animals or other things cannot affect your control of the machine.
 - To make sure that none of the above might come into contact with the cutting equipment.
- Do not use the machine in bad weather, such as dense fog, rain, strong wind, intense cold, etc. Working in bad weather is tiring and can lead to dangerous conditions, e.g. slippery surfaces.
- Never start to work with the power cutter before the working area is clear and you have a firm foothold. Look out for any obstacles with unexpected movement. Ensure when cutting that no material can become loose and fall, causing operating injury. Take great care when working on sloping ground.
- Make sure that no clothes or parts of the body come in contact with the cutting equipment when it is rotating.
- Keep at a safe distance from the cutting equipment when it is rotating.
- The guard for the cutting equipment must always be on when the machine is running.
- Ensure that the working area is sufficiently illuminated to create a safe working environment.
- Do not move the machine when the cutting equipment is rotating.
- Always ensure you have a safe and stable working position.
- Make sure that no pipes or electrical cables are routed in the area to be cut.

SAFETY INSTRUCTIONS

Cutting



WARNING! The safety distance for the power cutter is 15 metres. You are responsible to ensure that animals and onlookers are not within the working area. Do not start cutting until the working area is clear and you are standing firmly.

General

- Start cutting with the machine running at maximum speed.
- Always hold the machine in a firm grip with both hands. Hold it so that the thumbs and fingers grip round the handles.

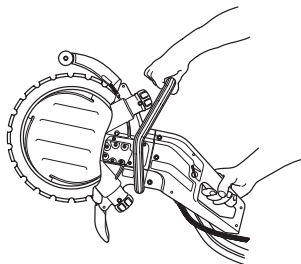

WARNING! Overexposure to vibration can lead to circulatory damage or nerve damage in people who have impaired circulation. Contact your doctor if you experience symptoms of overexposure to vibration. These symptoms include numbness, loss of feeling, tingling, pricking, pain, loss of strength, changes in skin colour or condition. These symptoms normally appear in the fingers, hands or wrists.

Cutting technique

The technique described below is of a general character. Check the details of each blade concerning individual cutting characteristics.

- Support the work piece in such a way that it is possible to predict what will happen, and so that the cut remains open while cutting.

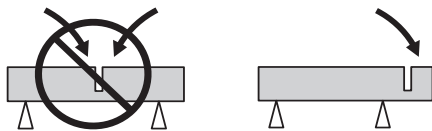

- Check that the blade is not in contact with anything when the machine is started.
- Always cut at maximum speed.
- Start cutting gradually, let the machine work without forcing or pressing the blade.

- Move the blade slowly backwards and forwards to give a small contact surface between the blade and material to be cut. This will mean the blade temperature is kept down resulting in efficient cutting.

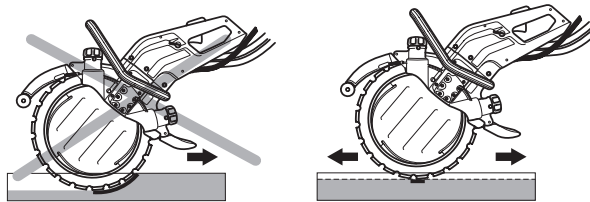

- Feed the machine in line with the blade. Side pressure can destroy the blade and is extremely dangerous.



WARNING! Under all circumstances avoid cutting with the side of the blade, as this will definitely result in damage, breakage or can cause serious injuries. Only use the cutting section.

Do not pull the power cutter to one side, this can cause the blade to jam or break resulting in injury to people.

Cutting depth

K3600 MKII can cut up to a depth of 260 mm (10 inches). Making a guide cut of 50-70 mm (2-3 inches) first, gives you better control of the machine. This means the water disc can penetrate into the workpiece and help control the machine. Attempting to saw the entire depth in one run takes longer. Working with several runs, 3 to 4 when the cut is 260 mm (10 inches) in depth, is much quicker.

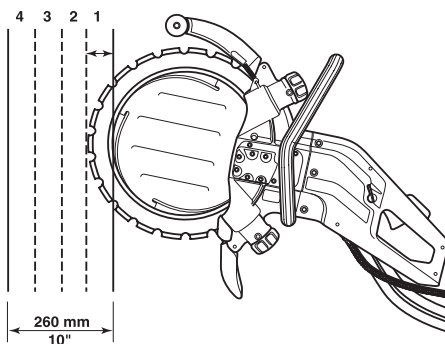

SAFETY INSTRUCTIONS

Large work

Cuts exceeding 1 m - secure a batten along the line to be cut. The batten acts as a guide. Use this guide to make a marking cut along the entire length of the cut, 50-70 mm (2-3 inches) in depth. Remove the guides once the marking cut has been made.

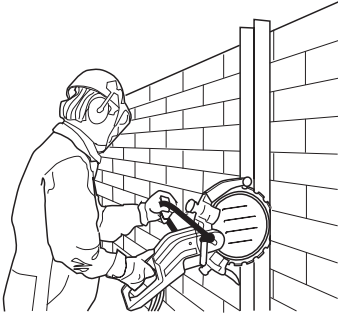

Small work

First make a shallow marking cut, max 50-70 mm (2-3 inches) in depth. Now make the final cut.

Cutting sequence

First make the lower horizontal cut. Now make the two vertical cuts. Finish with the upper horizontal cut.

Remember to divide the blocks up into manageable pieces so that they can be transported and lifted safely.

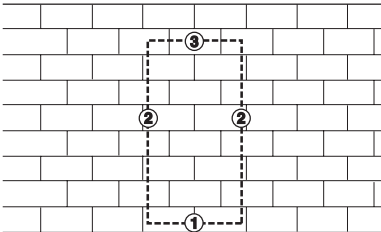

CAUTION! If the upper horizontal cut is made before the lower horizontal cut, the work piece will fall on the blade and jam it.

How to avoid kickback



WARNING! Kickback can happen very suddenly and violently; kicking the power cutter and cutting blade back at the user. If this happens when the cutting blade is moving it can cause very serious, even fatal injuries. It is vital you understand what causes kickback and that you can avoid it by taking care and using the right working technique.

What is kickback?

The word kickback is used to describe the sudden reaction that causes the power cutter and cutting blade to be thrown from an object when the upper quadrant of the blade, known as the kickback zone, touches an object.

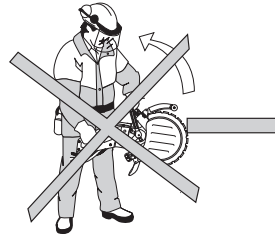

General rules

- Never start to cut with the upper quadrant of the blade as shown in the figure, also known as the kickback zone.

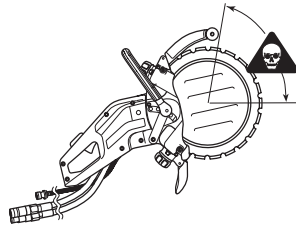

- Always hold the machine in a firm grip with both hands. Hold it so that the thumbs and fingers grip round the handles.

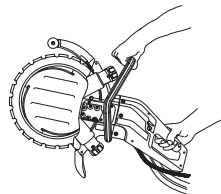

- Keep a good balance and a firm foothold.
- Always cut at maximum speed.
- Stand at a comfortable distance from the work piece.
- Take care when inserting the blade in an existing cut.
- Never cut above shoulder height.

SAFETY INSTRUCTIONS

- Be alert to movement of the work piece or anything else that can occur, which could cause the cut to close and pinch the blade.

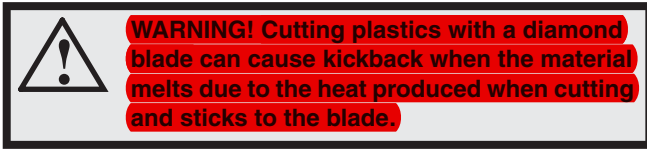

Pull in

Pull in occurs when the disc's lower section suddenly stops or when the cut closes. (To avoid, see the heading "Basic rules" and "Jamming/rotation", here below.)

Pinching/rotation

If the cut is pressed together this can lead to jamming. The machine can be pulled down suddenly with a very powerful jerk.

How to avoid pinching

Support the work piece in such a way that the cut remains open during the cutting operation and when the cut is finished.

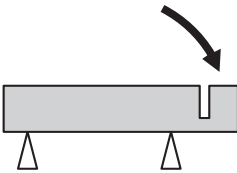

Diamond blades

Diamond blades consist of a steel body provided with segments that contain industrial diamonds.

Always use a sharp diamond blade. Sharpen the blade by cutting in a soft material such as sandstone or brick.

Diamond blades are available in several hardness classes. A "soft" diamond blade has a relatively short service life and large cutting capacity. It is used for hard materials such as granite and hard concrete. A "hard" diamond blade has a longer service life and reduced cutting capacity, and should be used for soft materials such as brick and asphalt.

Diamond blades are ideal for masonry, reinforced concrete and other composite materials. Diamond blades are not recommended for cutting metal.

Water cooling

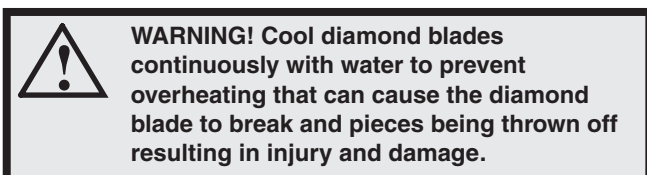

Diamond blades should be sprinkled with water while cutting to cool the blade and to bind dust that forms while cutting.

Sharpening diamond blades

Diamond blades can become dull when the wrong feeding pressure is used or when cutting certain materials such as heavily reinforced concrete. Working with a blunt diamond blade causes overheating, which can result in the diamond segments coming loose.

Sharpen the blade by cutting in a soft material such as sandstone or brick.

Vibrations on diamond blades

The blade can become out of round and vibrate if a too high feed pressure is used.

A lower feed pressure can stop the vibration. Otherwise replace the blade. The blade shall be intended for the material to be cut.

SETTINGS AND ADJUSTMENTS

Drive

On account of the machine's unique design the driving power is not transferred at the centre of the blade. The flanges on the two guide rollers run in the blade's grooves. Springs on the guide rollers press out the rollers, which in turn press the V-shaped edge on the inside diameter of the blade against the V-shaped groove in the drive wheel. The drive wheel is fitted on an axle which is driven by the hydraulic motor.

This allows a total cutting depth of 260 mm (10 inches) with a 350 mm (14 inches) diamond blade.

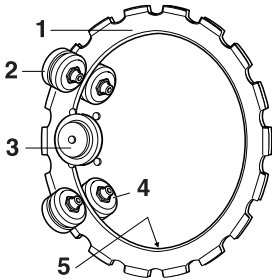

- 1 Blade
- 2 Support rollers
- 3 Drive wheel
- 4 Guide rollers
- 5 V-shaped edge

Basic service

As the blade is used the inside diameter and the groove in the drive wheel become worn.

The ring cutter will also work well in the future if:

- the drive wheel is not too worn
 - A) New
 - B) Worn
- the guide rollers are not too worn
 - A) New
 - B) Worn

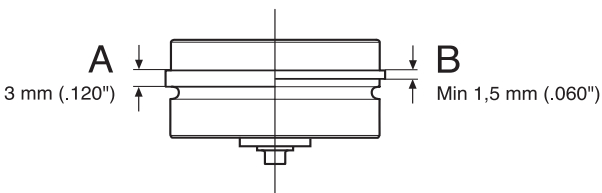
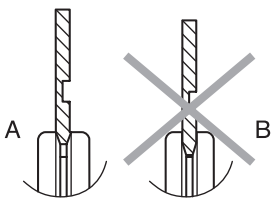

- adjustment between the rollers and blade is correct.

The roller setting should be checked twice during the life of the diamond blade, once after fitting the blade and when the blade is semi worn.

Fitting the blade



WARNING! Always disconnect the power cutter from the hydraulic connection when performing a service. Unexpected blade movements can cause serious injuries.

We offers a number of blades for different materials in its range. Check with your **Husqvarna** dealer to see which blades are best suited for your usage.

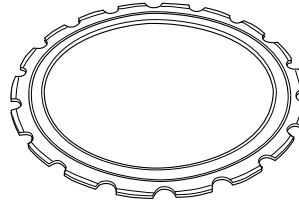

WARNING! It is forbidden to reconstruct a used blade. A used blade may be weakened. A reconstructed blade can crack or break into pieces and seriously injury the operator or other persons.



WARNING! Check that the blade is not damaged before fitting it on the machine. Damaged blades can disintegrate and cause serious personal injury.

- Wipe off any dirt from the surface of the blade.

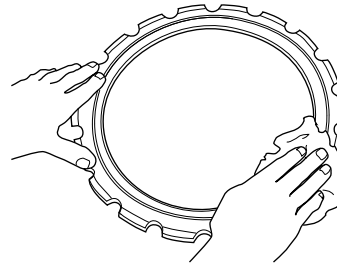

- Loosen the locking nuts on the support roller cover.

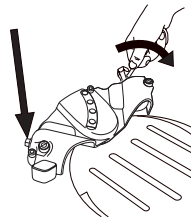

- Unscrew the adjuster screws a few turns.

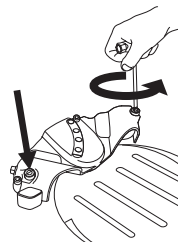

SETTINGS AND ADJUSTMENTS

- Loosen the knob to offload the springs.

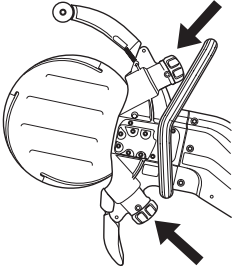

- Pull out the lock for the front handle and move the handle to the service position.

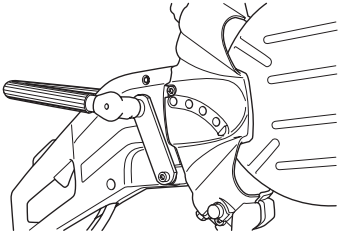

- Remove the three screws holding the support roller guard using a 6 mm hex key and lift off the cover.

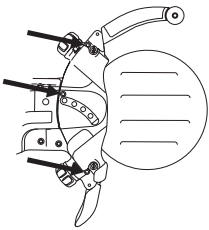

- Fit the blade.

CAUTION! The blade has a groove (A) on one side that acts as the guide groove for the support rollers. Ensure that the V-shaped edge of the blade enters the drive wheel and that the blade's guide groove fits in the guide rollers. Also see under the heading Drive.

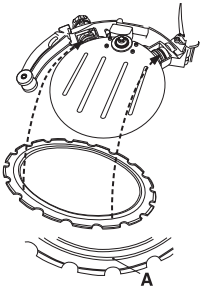

- Press in the guide roller if necessary, so that it climbs into the groove on the blade.

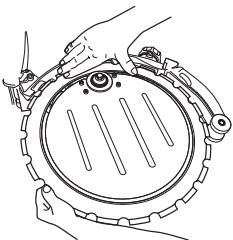

- Fit the support roller guard and ensure that the flanges on the guide rollers still enter the blade's grooves correctly. Now tighten the three screws fully.

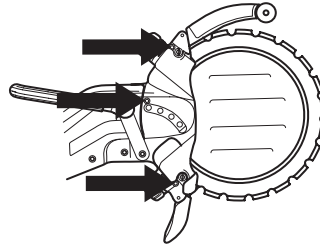

- Rotate the blade and make sure that the support rollers are not clamped against the blade.

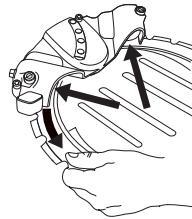

- Adjust the adjuster screws so that the support rollers make contact against the blade.

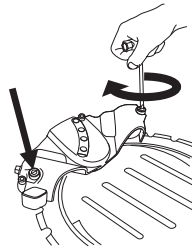

- Adjust so you can easily stop the support rollers using your thumb when the blade is rotated. The support rollers should only follow the blade occasionally.

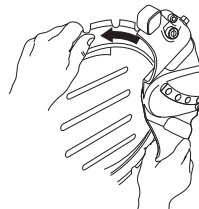

- Tighten the locking nuts on the support roller guard.

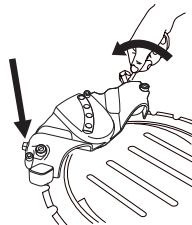

- Rotate the blade and make sure you can still hold the rollers with your thumb when the blade is rotated.

SETTINGS AND ADJUSTMENTS

CAUTION! The machine should be upright. If the machine lies on its side the weight of the blade makes it difficult to make a correct adjustment.

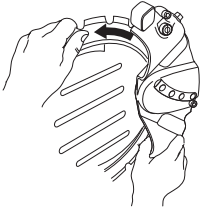

- Tighten the knobs fully and the machine is ready to use.

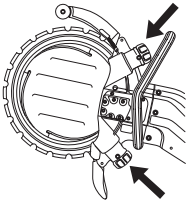

Hydraulic hoses



WARNING! The power cutter must not be connected to a hydraulic pressure exceeding 150 bar (3000 psi).

- Before connecting the hoses: Ensure that the couplings are clean, both on the machine and the hoses.
- Connect the pressure hose (A) from the hydraulic system to the female coupling on the machine.
- Connect the other hydraulic coupling (B) to the male coupling. This hose leads oil back to the container.

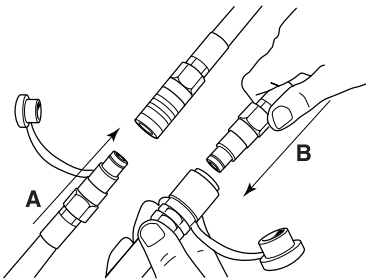

CAUTION! Two hose kits can be connected when hose lengths exceeding 18 m are required. Do not connect more than two kits as the couplings cause large power loss. See the Technical data.

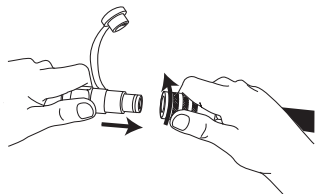

CAUTION! Make sure that the hoses can not be loosened accidentally by turning the safety catches on the couplings to the locked position before using the machine.



WARNING! When the machine is in operation the hoses are under extreme pressure. Do not try to connect or disconnect the hoses when the hydraulic system is operational. This can result in serious personal injuries.

Water hose

Connect the water hose to the water supply. The water flow is activated by opening the check valve. Minimum water flow: 4 l/min Note that the machine's hose nipple is fitted with a filter.

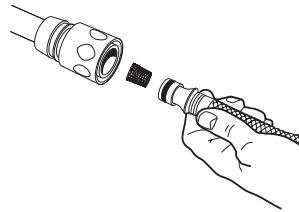

Water supply

When you press in the switch lock (A) the water valve opens.

The water valve remains open and the switch lock (A) remains pressed in as long as the switch (B) is held pressed in.

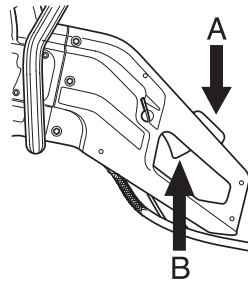

Water dosage

The water flow can be adjusted during operations with your thumb.

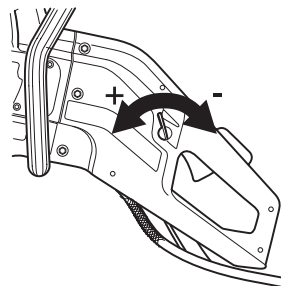

Ample water flow is needed for maximal blade life.

CAUTION! The water pressure and water flow is extremely important for the blade's cooling and service life. Inadequate cooling shortens the life of the guide rollers, drive wheel and the blade.

STARTING AND STOPPING

Starting and stopping



WARNING! Note the following before starting:

Make sure you are standing properly and that the blade can not come into contact with anything.

Keep people and animals well away from the working area.

Check that the power source (the hydraulic unit) supplies the correct oil flow and oil pressure.

Starting

- Grip the front handle with the left hand.

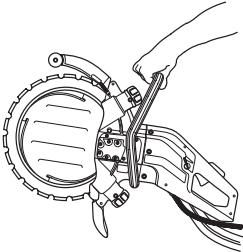

- Grip the rear handle with the right hand. When you grip the rear handle this releases the switch lock.

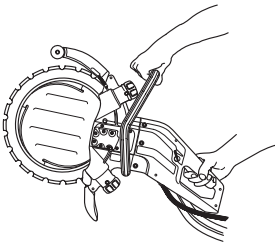

Stopping

The machine is stopped by releasing the switch.

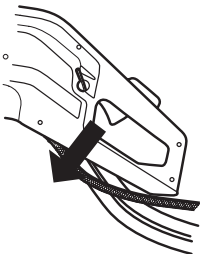

MAINTENANCE

Maintenance

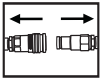

WARNING! Inspection and/or maintenance should be carried out with the hydraulic hoses disconnected.

Dismantling the complete guide roller

- Remove the support roller cover.

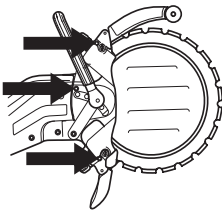

- Lift off the blade.

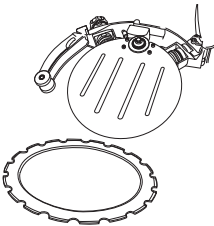

- Unscrew the knob. First turn the knob a few turns until you feel a resistance. The guide roller then follows the knob out and stops when it feels a resistance.

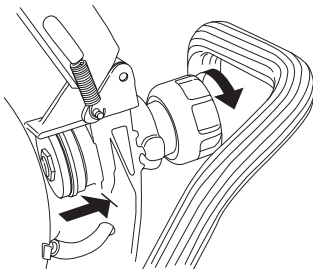

The guide roller is pressed into the knob. In order to loosen the guide roller, you need to continue turning the knob until it loosens completely.

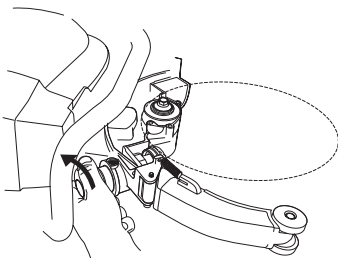

- The guide roller can now be pulled out of the chassis

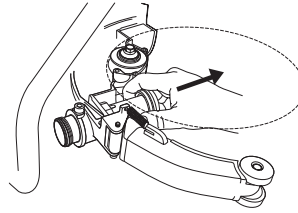

Assembling the complete guide roller

- Screw the knob until it bottoms, and then loosen the knob 2 turns.

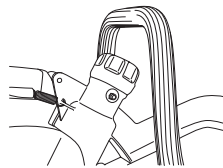

- Insert the guide roller in the chassis

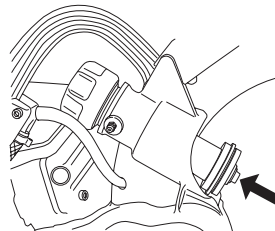

- Now press the guide roller into the knob.

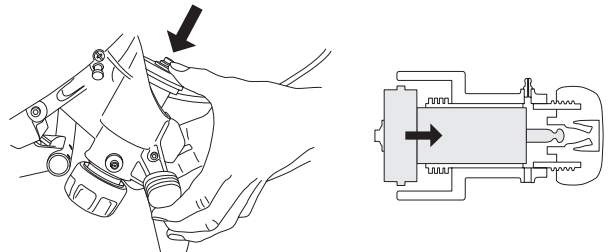

Lubricate the guide roller's sleeve using grease. Fit the grease gun on the grease nipples (A) and pump in grease until clean grease emerges from the overflow hole (B).

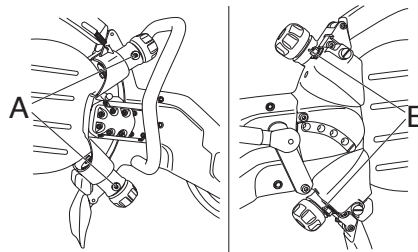

- Fit the blade. See the heading Fitting the blade.

Important notes:

- The support rollers do not drive the blade.
- Incorrect adjustment can result in damage to the blade.
- If the blade rotates slowly or stops, stop cutting immediately and trouble shoot.

MAINTENANCE

Drive wheel

- 1 Lock the axle using the locking button. See the instructions under the heading What is what?.
- 2 Loosen the centre screw and remove the washer.

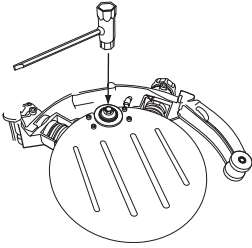

- 3 You can now lift off the drive wheel.

CAUTION! Replace the drive wheel when fitting a new blade. A worn drive wheel can result in the blade slipping and becoming damaged.

Inadequate water flow drastically shortens the life of the drive wheel.

Replacing the support rollers/guide rollers

- Remove the support roller cover.

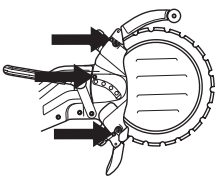

- Check the rollers for wear.
- Use a 19 mm spanner and 5 mm hex key to replace the rollers.

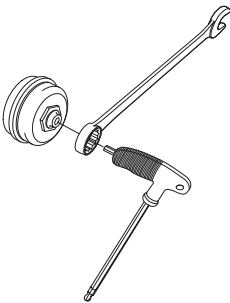

Lubricate using bearing grease inside the rollers before the new rollers are fitted.

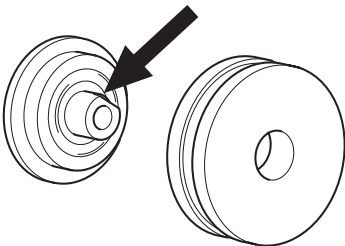

- Replace the guide rollers **when half of the flange** on the rollers is worn.

A) New

B) Worn

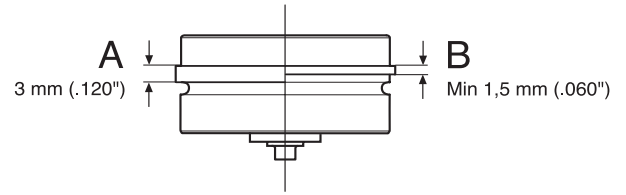

- Replace the support rollers when the roller surface is flat, (or) when the groove on the roller surface has worn away.

A) New

B) Worn

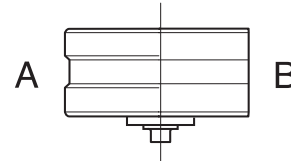

When worn rollers are replaced with new ones, you must adjust the rollers against the blade. See the instructions under the heading Settings and adjustments.

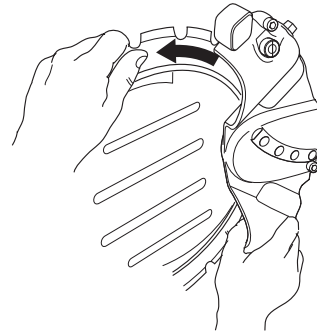

Reconstructing the blade



WARNING! Ring cutter blades must not be reconstructed. Due to its design, a ring cutter blade is exposed to other strains than a centre driven 14 inch diamond blade. Firstly, the drive wheel is driven on the inner diameter of the blade so that both the surfaces of the drive wheel and the blade are exposed to wear. The core of the blade becomes thinner and the guide wider, which prevents the blade being driven by the wheel. Secondly, the blade is exposed to loads from the rollers and from the actual cutting process when the blade is not held completely straight. Strain builds up in the blade until it cracks or breaks if it has been reconstructed. A shattered blade can cause serious personal injuries to the user or other persons. **For this reason Husqvarna does not approve ring cutting blades that have been reconstructed. Contact your Husqvarna dealer for instructions.**

Couplings

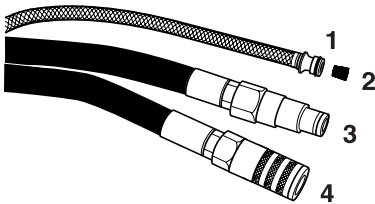

- 1 Water
- 2 Water filter
- 3 Return
- 4 Pressure

IMPORTANT! If the coupling is dirty, the dirt can enter the oil and cause increased wear on the hydraulic motor, hydraulic pump, valves, etc. It can also prevent the coupling from sealing correctly.

Always clean the couplings before connecting to the hydraulic system and the machine. Make sure the lock moves easily.

Clean the water filter if necessary.

Hydraulic hoses

Check the hydraulic hoses everyday before the machine is used. Cracked, creased or weakened hoses must be replaced.

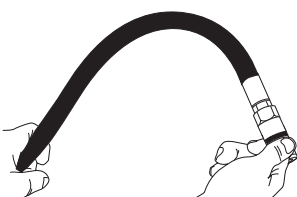

MAINTENANCE

Maintenance schedule

CAUTION! The chart is based on daily use of the equipment.

	Daily	Twice a week
Support and guide rollers		
Check the support rollers with regard to wear.		X
Check the guide rollers with regard to wear.	X	
Lubricate the guide rollers.	X	
Hydraulic System		
Inspect the hydraulic hoses.	X	
Inspect and clean the water nozzle.	X	
Drive system		
Check the condition of the drive wheel.		X
Water system		
Inspect and clean the water nozzles on the water disc.		X
Inspect the water adjustment control.		X
Check the filter in the water coupling.		X
Controls		
Check that the controls work.	X	
Blade		
Check the condition of the blade guard.	X	
Check the water disc.		X

Blades conforming to EN13236

Husqvarna K3600 MKII only conforms to 98/37/EC and EN13236 together with the blades listed below:

Type	Diameter, mm
Husqvarna	
PXR XX	350
ELR XX (5,6 / ,220)	350
SLR XX	350
R550-0355 (5,6 mm)	350
R530-0355	350
R510-0355 (5,6 mm)	350

Note: The blades are available in different hardnesses for different materials, this is stated with two digits, XX.

TROUBLE SHOOTING

Mechanics

Symptom	Probable cause
The blade does not rotate.	Roller knobs not tightened fully.
	The blade not fitted on guide rollers correctly.
	Rollers tensioned too much.
	Possible faulty hose connection to the hydraulic system.
	Possible faulty hose connection to the drive source or other hydraulic problem.
The blade rotates too slowly.	Roller knobs not tightened fully.
	Worn drive wheel.
	The V-shaped inner diameter of the blade is worn.
	The springs on the guide rollers are weakened.
	Dirty overpressure valve in the hydraulic system.
	Valve knob on the hydraulic motor does not move the correct distance.
	Defective roller bearings.
	Inadequate oil flow, check the hydraulic oil flow.
The blade jumps out of its position.	Roller setting too loose.
	Worn guide rollers.
	The blade not fitted on guide rollers correctly.
	Damaged blade.
The blade warps.	Rollers tensioned too much.
	Blade overheating.
Segments break.	Bent, twisted or badly maintained blade.
The blade cuts too slowly.	Wrong blade for the material in question.
	Check that the right amount of water reaches the blade.
The blade slips.	The guide rollers does not move in and out freely. A seized roller can not press the blade hard enough against the drive wheel.
	Worn drive wheel. Abrasive material and too little water when cutting increases the wear on the wheel.
	Worn guide roller flange. When more than half of the width of the flange is worn the blade slips.
	The blade's groove and inner edge are worn. Caused by inferior flushing of abrasive material and/or a worn drive wheel causing the blade to slip.

TECHNICAL DATA

Technical data	K3600 MKII
Blade diameter, mm/inches	350/14"
Cutting depth, mm/inches	260/10"
Max. peripheral speed, m/s / r/min	55/3000
Max. motor speed, r/min	17000
Hydraulic motor	Geared motor (open centre valve)
Max. hydraulic pressure, bar/ (psi)	150 / 2200
Oil flow, min-max, l/min	35-42
Height, mm/inches	410
Length, mm/inches	715
Width, mm/inches	260
Weight, excl. blade, kg	8,3
Weight ring blade, kg	0,8
Specifications hydraulic oil*	150 VG 32 (10W)**
Oil temperature (operational), °C	60
Water consumption, l/min	4
Hydraulic couplings	1/2" FF according to HTMA regulations. (thread 3/8")

*We recommend the use of environmentally approved hydraulic oil.

**With high ambient temperatures use oil with a higher viscosity.

Noise emissions

(see note 1)

Sound power level, measured dB(A)	110
Sound power level, guaranteed L_{WA} dB(A)	111

Sound levels

Equivalent sound pressure level at the operator's ear, according to ISO/DIS 15744 and ISO/DIS 11201, dB (A)	99
---	----

Vibration levels

Handle vibrations measured according to ISO/DIS 8662-4	
Front handle, m/s^2	4,3
Rear handle, m/s^2	6,0

Note 1: Noise emissions in the environment measured as sound power (L_{WA}) in conformity with EC directive 2000/14/EC.

Extending the hydraulic hoses

When extending the hydraulic hoses, the inside diameter of the hose must be increased according to the table to counteract power loss.

Extension, m	Inside diameter of the hydraulic hose, inches
Up to 30 m	1/2
30-45	5/8
45-100	3/4

TECHNICAL DATA

EC-declaration of conformity

Husqvarna Construction Products, SE-433 81 Partille, Sweden, tel: +46-31-949000, declares under sole responsibility that the power cutter **Husqvarna K3600** from 2006's serial numbers and onwards (the year is clearly stated in plain text on the rating plate with subsequent serial number), complies with the requirements of the COUNCIL'S DIRECTIVES:

- of June 22, 1998 "relating to machinery" **98/37/EC**, annex IIA.
- of May 8, 2000 "relating to the noise emissions in the environment" **2000/14/EC**.

The following harmonised standards have been applied: **ISO/DIS 15744, ISO/DIS 11201**.

SMP Svensk Maskinprovning AB, Fyrisborgsgatan 3, SE-754 50 Uppsala, Sweden, has carried out voluntary type approval for Husqvarna AB.

The certificate has the number: **01/169/010** – K3600 MKII.

Partille January 3, 2006



Ove Donnerdal, Development Manager



1150294-26



2006-12-15