



# SPARE PARTS LIST

POWER CUTTERS

K40, 2007-01

**A** K30/K40

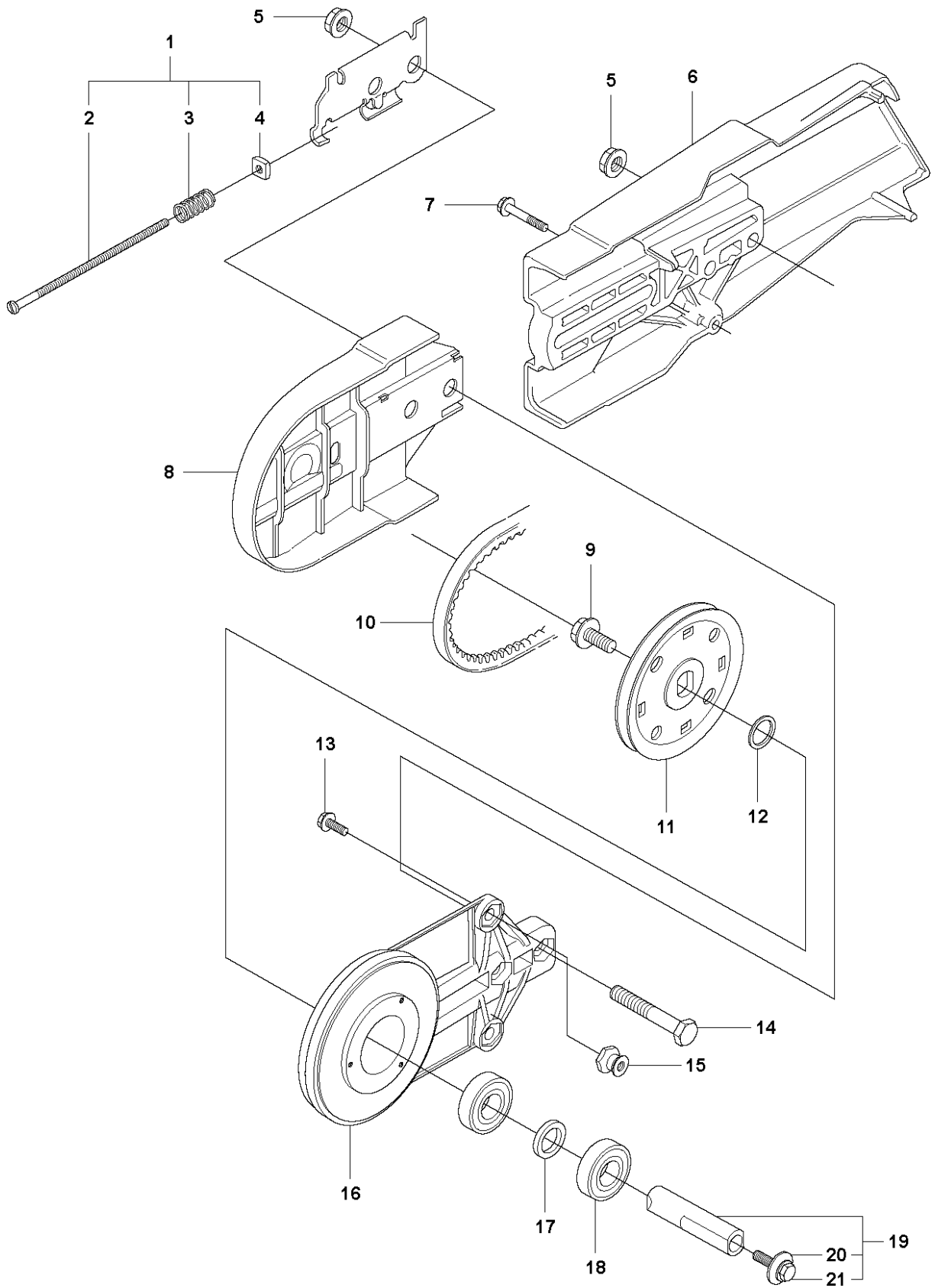

## BELT GUARD &amp; PULLEY

K40, 2007-01

Ref	Part No	Description	Remark	QTY KIT
1	506 03 06-02	BELT TENSIONER ASSY	Incl. 2, 3, 4	1
2	503 20 30-09	SCREW SLCHM		1
3	506 21 95-01	COMPRESSION SPRING		1
4	503 22 66-01	SQUARE NUT		1
5	503 22 00-01	HEXAGON NUT		4
6	506 02 90-02	CUTTER ARM		1
7	503 20 00-01	SCREW EHHFM		1
8	506 02 92-11	BELT GUARD		1
9	503 20 00-45	SCREW EHHFM		1
10	506 27 67-44	BELT		1
11	506 03 00-01	PULLEY		1
12	503 23 01-04	WASHER		1
13	503 20 00-04	SCREW EHHFM		1
14	506 03 32-02	SCREW		2
15	506 14 32-01	TORSION STOP		1
16	506 02 91-11	HOUSING		1
17	506 02 86-01	SPACING SLEEVE		1
18	503 25 21-01	BALL BEARING		2
19	506 29 83-63	SHAFT	Incl. 20, 21	1
20	506 13 95-11	WASHER		1
21	506 13 96-01	SCREW EHHFM		1

**D** K30/K40

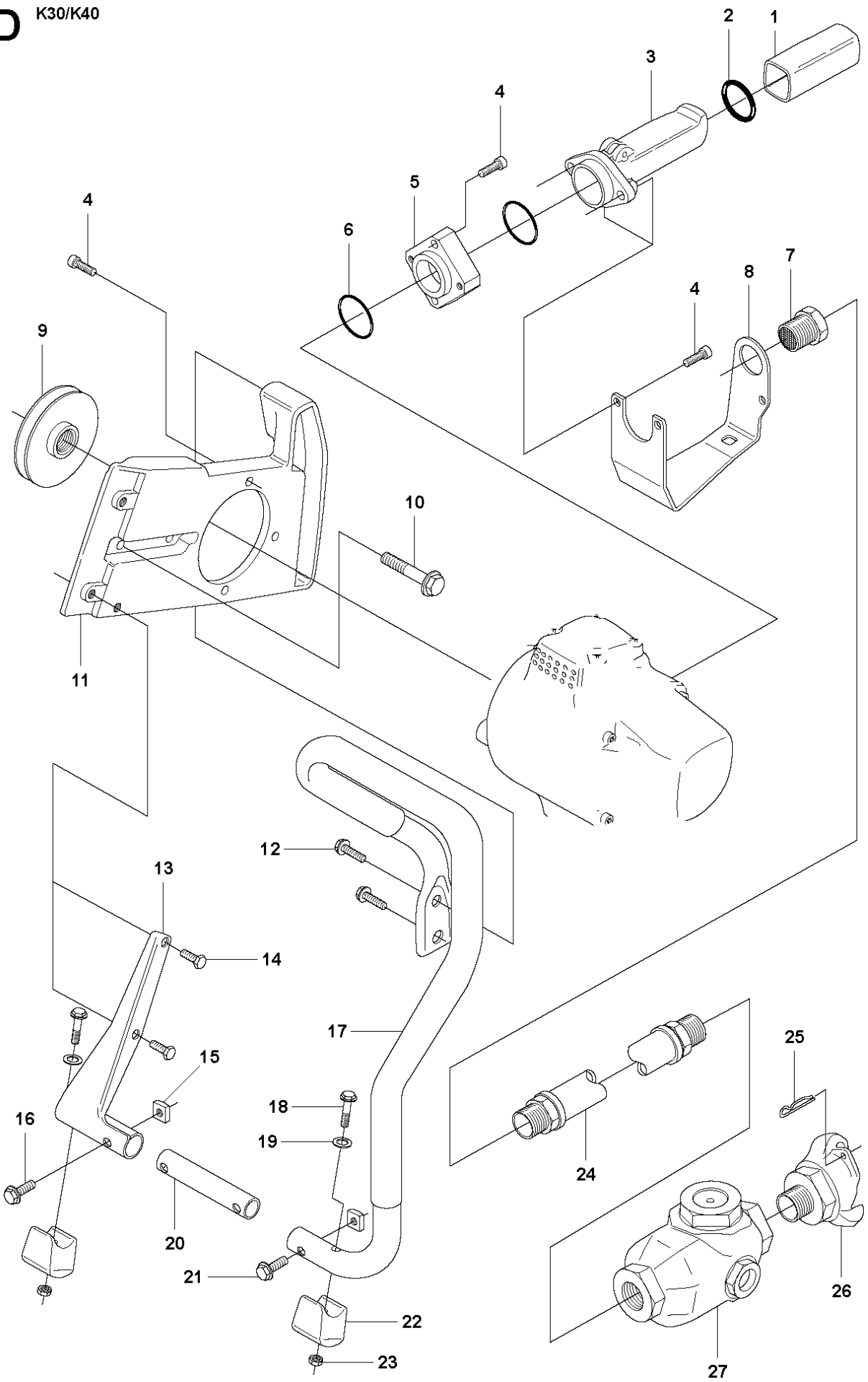

Ref	Part No	Description	Remark	QTY KIT
1	506 19 17-01	GRIP		1
2	503 26 30-16	O-RING		1
3	506 19 08-01	HANDLE		1
4	725 53 70-06	SCREW IHSCM		6
5	506 20 41-01	MANIFOLD		1
6	740 48 27-02	O-RING		2
7	506 19 06-01	FITTING		1
8	506 23 48-02	COVER		1
9	506 19 22-02	GEAR WHEEL		1
10	506 03 32-02	SCREW		2
11	506 19 20-02	ENGINE PLATE		1
12	503 20 00-04	SCREW EHHFM		2
13	506 14 42-01	GROUND SUPPORT		1
14	503 20 00-03	SCREW EHHFM		2
15	503 22 65-04	SQUARE NUT		2
16	503 20 00-16	SCREW EHHFM		1
17	506 07 26-05	FRONT HANDLE		1
18	503 20 00-07	SCREW EHHFM		2
19	503 23 00-35	WASHER		2
20	506 19 23-02	SPACER		1
21	503 20 00-05	SCREW EHHFM		1
22	506 14 43-02	GROUND SUPPORT		2
23	732 21 14-01	LOCK NUT		2
24	506 19 10-01	HOSE		1
25	721 68 01-51	SPRING COTTER		1
26	506 19 72-01	KLOKOPPLING 1/2"		1
27	506 19 11-01	OILER		1

**F** K30/K40

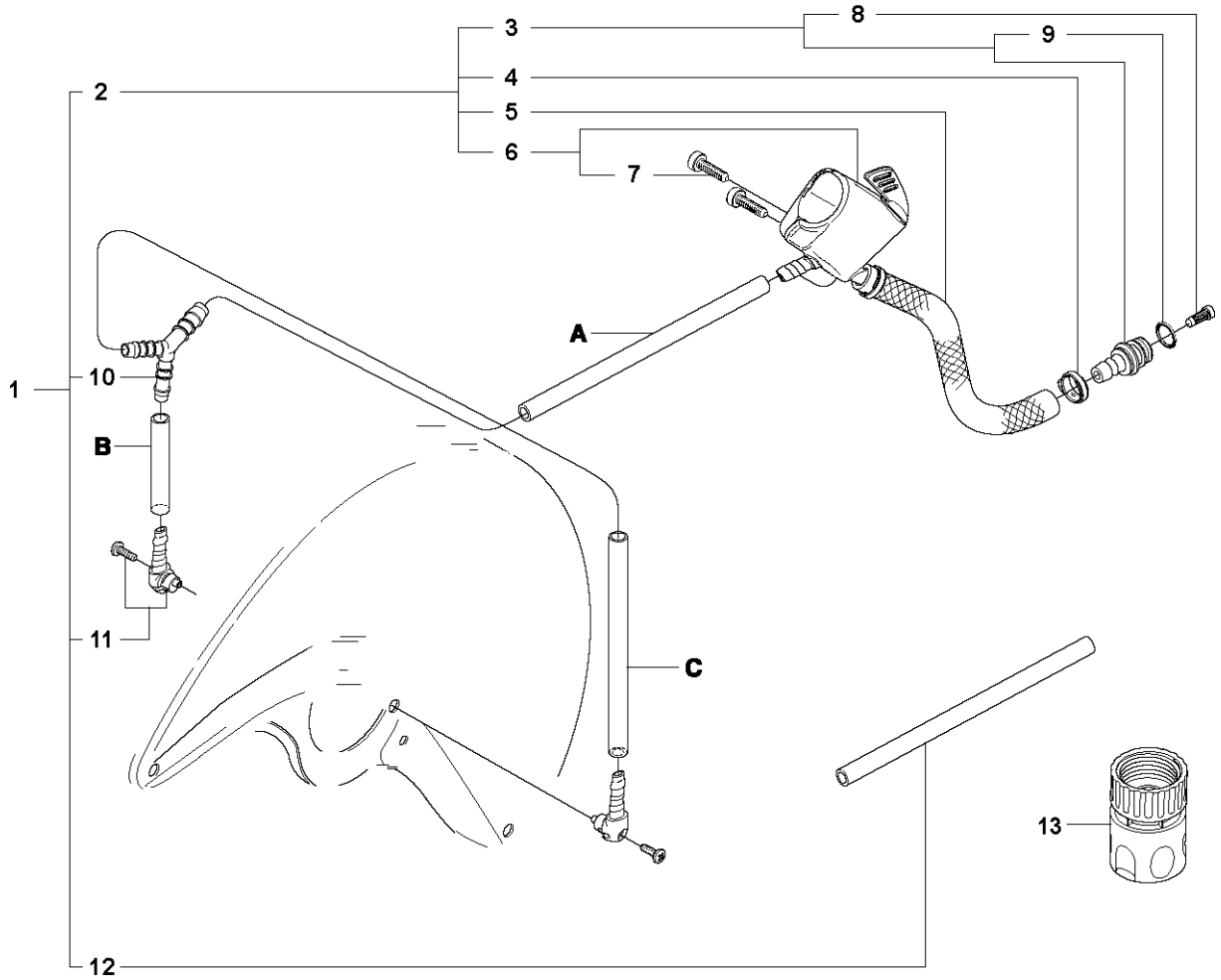

Product		A (mm)	B (mm)	C (mm)
K30	12"	270	45	210
K40	14"	240	45	300

## HOSE

K40, 2007-01

Ref	Part No	Description	Remark	QTY KIT
1	506 32 89-03	HOSE KIT	Incl. 2 - 13	1
2	506 32 90-21	VALVE ASSY		1
3	506 29 57-02	NIPPLE		1
4	506 09 56-02	HOSE CLAMP		2
5	506 09 75-02	HOSE	L=230mm	1
6	506 31 77-31	VALVE ASSY	Incl. 7	1
7	503 21 06-19	SCREW IHST		2
8	506 29 88-01	FILTER		1
9	503 26 30-21	O-RING		1
10	506 32 87-01	Y-TUBE		1
11	506 29 56-01	NIPPLE		2
12	506 09 58-24	HOSE		1
13	503 26 60-02	COUPLER		1

**E** K30/K40

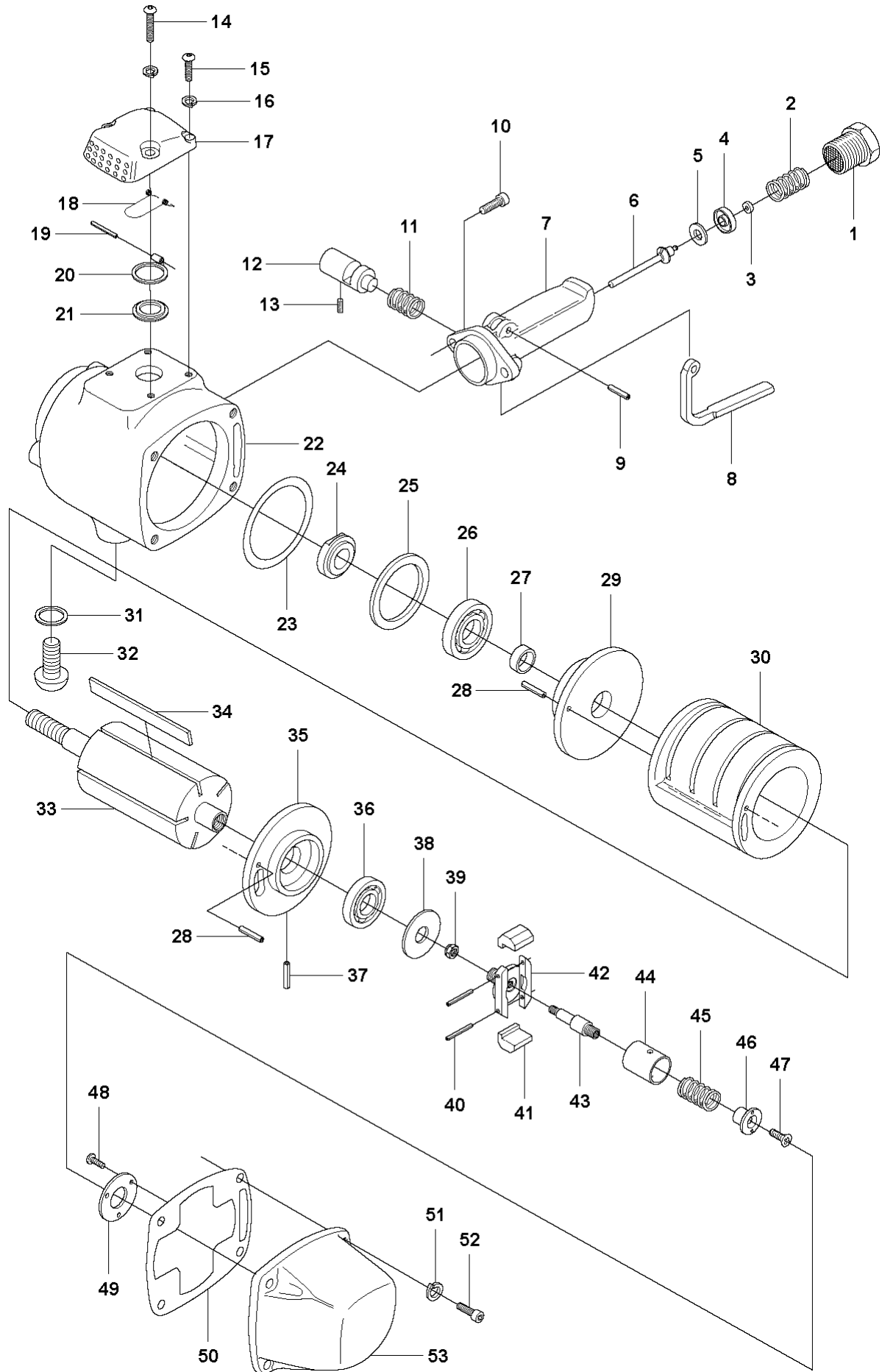



## MOTOR

K40, 2007-01

Ref	Part No	Description	Remark	QTY KIT
1	506 19 06-01	FITTING		1
2	506 19 29-01	SPRING		1
3	506 19 41-01	THROTTLE VALVE		1
4	506 19 27-01	WASHER		1
5	506 19 26-01	VALVE		1
6	506 19 28-01	SHAFT		1
7	506 19 08-01	HANDLE		1
8	506 19 18-01	LEVER		1
9	506 19 58-01	PIN RETAINING SCREW		1
10	725 53 72-55	SCREW IHSCM		2
11	506 19 40-01	SPRING		1
12	506 19 39-01	KNOB		1
13	506 19 65-01	SCREW		1
14	725 52 99-05	SCREW IHSCM		2
15	725 52 95-55	SCREW IHSCM		2
16	735 21 36-01	LOCKWASHER		4
17	506 19 51-01	COVER	K40	1
18	506 19 53-01	SPRING		1
19	506 19 60-01	PIN RETAINING SCREW		1
20	506 19 54-01	HOLDER		1
21	506 19 52-01	VALVE		1
22	506 19 42-01	HOUSING	K40	1
23	506 19 49-01	ADJUSTING WASHER		1
24	506 19 47-01	ROTOR NUT		1
25	506 19 57-01	BEARING		1
26	506 19 15-01	BALL BEARING		1
27	506 19 48-01	ADJUSTING SLEEVE		1
28	506 19 61-01	PIN RETAINING SCREW		2
29	506 19 46-01	BEARING HOUSING		1
30	506 19 44-11	CYLINDER	K30	1
30	506 19 44-01	AIR CLEANER	K40	1
31	506 19 55-01	SPRING		1
32	506 19 63-01	SCREW		1
33	506 19 43-11	ROTOR	K30	1
33	506 19 43-01	ROTOR	K40	1
34	506 19 16-11	ROTOR	K30	5
34	506 19 16-02	ROTOR BLADE, SET	K40	5
35	506 19 45-01	BEARING HOUSING		1
36	503 25 00-02	BALL BEARING		1
37	506 19 62-01	PIN RETAINING SCREW		1
38	506 19 50-01	WASHER		1
39	731 23 14-05	HEXAGON NUT		1
40	506 19 59-01	PIN RETAINING SCREW		2
41	506 19 35-11	WEIGHT	K30	2
41	506 19 35-01	REGULATOR WEIGHT	K40	2
42	506 19 34-01	HOLDER		1
43	506 19 37-01	SHAFT		1
44	506 19 31-01	SLEEVE		1
45	506 19 32-11	SPRING	K30	1
45	506 19 32-01	SPRING	K40	1
46	506 19 38-01	VALVE		1
47	724 32 91-01	SCREW		1
48	723 12 89-51	SCREW SLCHM		3
49	506 19 56-01	WASHER		1
50	506 19 13-01	GASKET		1
51	735 11 53-50	SPRING WASHER		4
52	725 53 70-55	SCREW IHSCM		4
53	506 19 12-01	COVER		1

**G** K30/K40

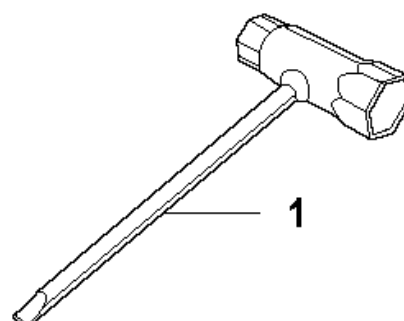

TOOLS

K40, 2007-01

Ref	Part No	Description	Remark	QTY KIT
1	501 69 17-02	COMBINATION WRENCH		1

**C** K30/K40

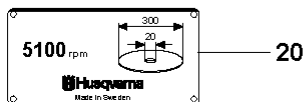
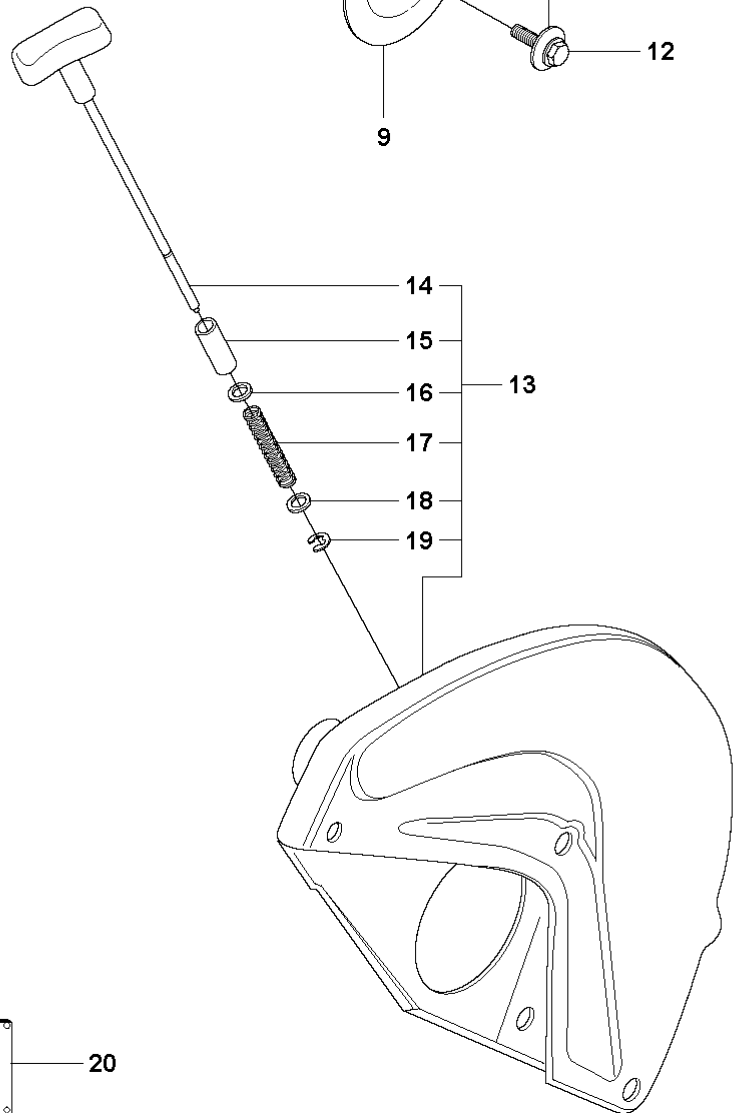
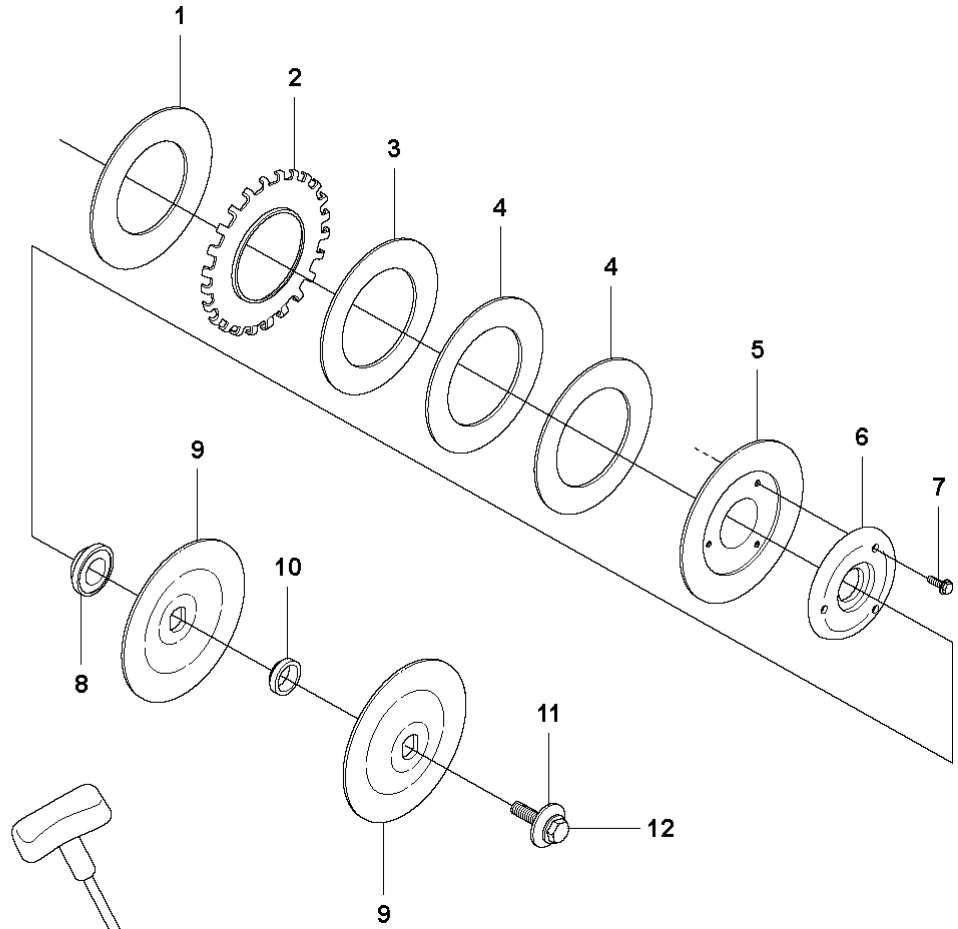

## WHEELS &amp; TIRES

K40, 2007-01

Ref	Part No	Description	Remark	QTY KIT
1	506 03 62-01	INTERLAYER		1
2	506 02 84-01	LOCKWASHER		1
3	506 03 62-02	INTERLAYER		1
4	506 03 62-04	INTERLAYER		2
5	506 03 45-01	SPRING WASHER		1
6	506 26 75-01	GROMMET		1
7	503 20 00-03	SCREW EHHFM		3
8	506 07 07-01	SUPPORT FLANGE		1
9	506 02 87-01	FLANGE WASHER		2
10	506 02 88-30	BUSHING	Diam 30,5mm	1
10	506 37 96-20	KIT	Diam 20mm	1
10	506 37 96-22	KIT	Diam 22,2mm	1
10	506 37 96-25	KIT	Diam 25mm	1
11	506 13 95-11	WASHER		1
12	506 13 96-01	SCREW EHHFM		1
13	506 14 27-11	WHEEL GUARD ASSY	Incl. 14 - 19	1
14	506 02 98-01	SPAK D300 SVART		1
15	506 02 95-01	HOSE		1
16	503 23 00-05	WASHER		1
17	506 02 96-01	SPRING		1
18	506 21 21-01	WASHER		1
19	735 31 09-20	HARNESS		1
20	506 28 41-02	LABEL		1

**B** K30/K40

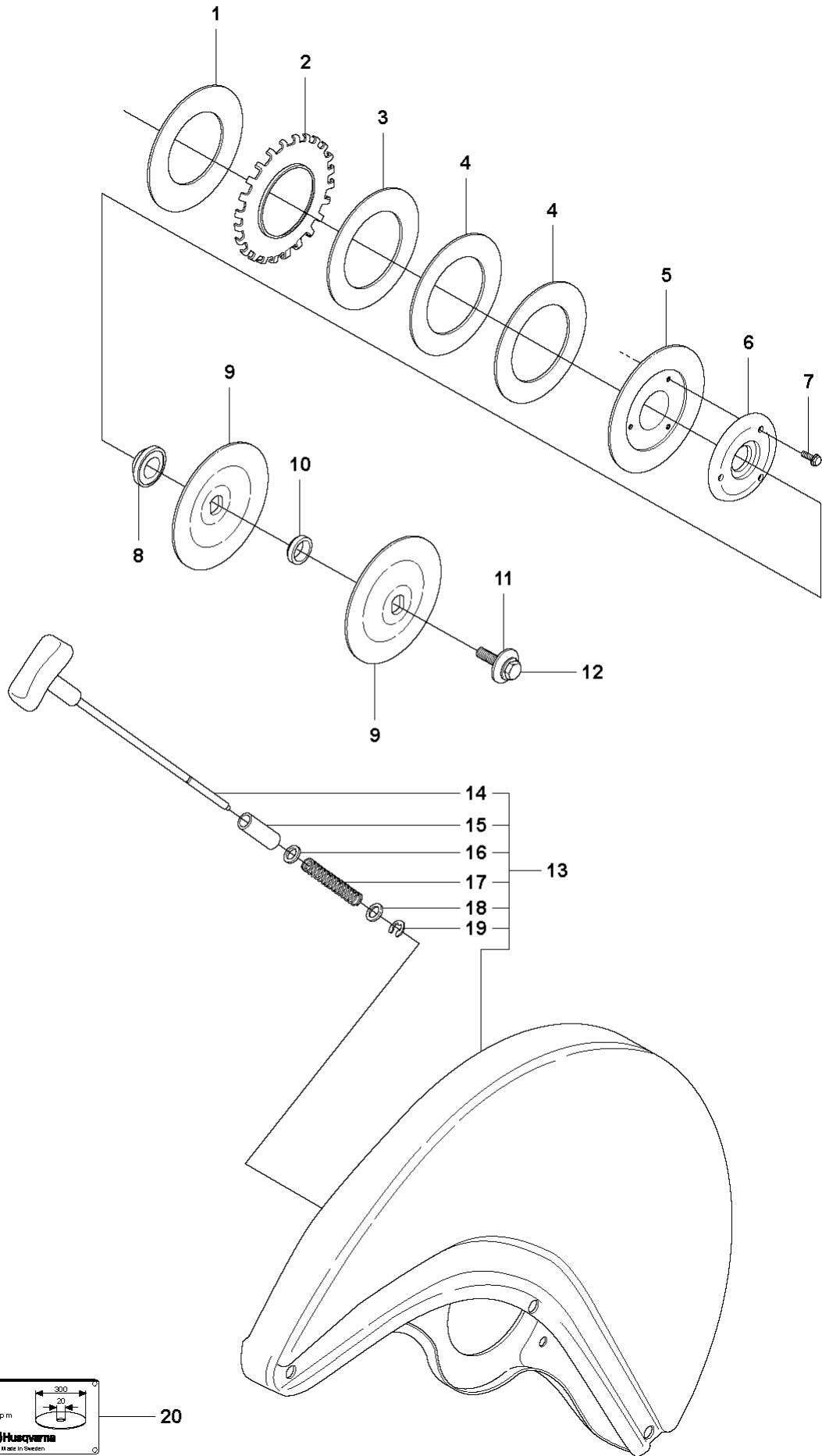

## WHEELS &amp; TIRES

K40, 2007-01

Ref	Part No	Description	Remark	QTY KIT
1	506 03 62-01	INTERLAYER		1
2	506 02 84-01	LOCKWASHER		1
3	506 03 62-02	INTERLAYER		1
4	506 03 62-04	INTERLAYER		2
5	506 03 45-01	SPRING WASHER		1
6	506 26 75-01	GROMMET		1
7	503 20 00-03	SCREW EHHFM		3
8	506 07 07-01	SUPPORT FLANGE		1
9	506 07 09-01	FLANGE WASHER		2
10	506 02 88-30	BUSHING	Diam 30,5mm	1
10	506 37 96-20	KIT	Diam 20mm	1
10	506 37 96-22	KIT	Diam 22,2mm	1
10	506 37 96-25	KIT	Diam 25mm	1
11	506 13 95-11	WASHER		1
12	506 13 96-01	SCREW EHHFM		1
13	506 13 90-11	WHEEL GUARD	Incl. 14 - 19	1
14	506 02 98-04	SPAK D350 SVART		1
15	506 02 95-03	HOSE		1
16	503 23 00-05	WASHER		1
17	506 02 96-01	SPRING		1
18	506 21 21-01	WASHER		1
19	735 31 09-20	HARNESS		1
20	506 28 41-14	LABEL		1