

# **Operator's manual** **K960 Ring**

Please read the operator's manual carefully and make sure you understand the instructions before using the machine.

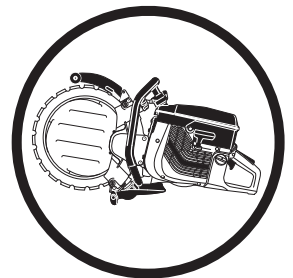

**English**

# KEY TO SYMBOLS

## Symbols on the machine:

**WARNING!** The machine can be a dangerous tool if used incorrectly or carelessly, which can cause serious or fatal injury to the operator or others.



Please read the operator's manual carefully and make sure you understand the instructions before using the machine.



Always wear:

- Protective helmet
- Hearing protection
- Protective goggles or a visor
- Breathing mask



**WARNING!** Dust forms when cutting, this can cause injuries if inhaled. Use an approved breathing mask. Avoid inhaling petrol fumes and exhaust fumes. Always provide for good ventilation.



**WARNING!** Kickbacks can be sudden, rapid and violent and can cause life threatening injuries. Read and understand the instructions in the manual before using the machine.



**WARNING!** Sparks from the cutting blade can cause fire in combustible materials such as: petrol (gas), wood, dry grass etc.



## Symbols in the operator's manual:

Switch off the engine by moving the stop switch to the STOP position before carrying out any checks or maintenance.

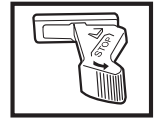

Run position.



Stop, with the return spring to the operating position.



Stop, in the fixed position.

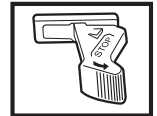

Always wear approved protective gloves.



Regular cleaning is required.

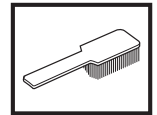

Visual check.



Protective goggles or a visor must be worn.



**Other symbols/decals on the machine refer to special certification requirements for certain markets.**

---

# CONTENTS

---

## Contents

### KEY TO SYMBOLS

Symbols on the machine: .....	2
Symbols in the operator's manual: .....	2

### CONTENTS

Contents .....	3
----------------	---

### WHAT IS WHAT?

What is what on the power cutter? .....	4
---	---

### SAFETY INSTRUCTIONS

Steps before using a new power cutter .....	5
Personal protective equipment .....	5
General safety precautions .....	6
Machine's safety equipment .....	7
Checking, maintaining and servicing the machine's safety equipment .....	9
General working instructions .....	10

### SETTINGS AND ADJUSTMENTS

Drive .....	13
Fitting the blade .....	13
Dismantling the complete guide roller .....	15
Assembling the complete guide roller .....	15
Important notes: .....	15
Replacing the drive wheel .....	16
Replacing the support rollers/guide rollers .....	16
Water hose .....	16

### FUEL HANDLING

Fuel .....	17
Mixing ratio .....	17
Fueling .....	17

### STARTING AND STOPPING

Before starting .....	18
Starting .....	18

### MAINTENANCE

Lubricating the guide rollers .....	19
Adjusting the drive belt .....	19
Belt tensioning/replacing the drive belt .....	19
Belt pulley and clutch .....	19
Carburetor .....	20
Fuel filter .....	20
Air filter .....	20
Starter .....	21
Spark plug .....	22
Cooling system .....	23
Muffler .....	23
Reconstructing the blade .....	23
General maintenance instructions .....	24
Trouble shooting .....	25

### TECHNICAL DATA

Technical data .....	26
Cutting equipment .....	26

### FEDERAL EMISSION CONTROL WARRANTY STATEMENT

YOUR WARRANTY RIGHTS AND OBLIGATIONS .....	27
--	----

# WHAT IS WHAT?

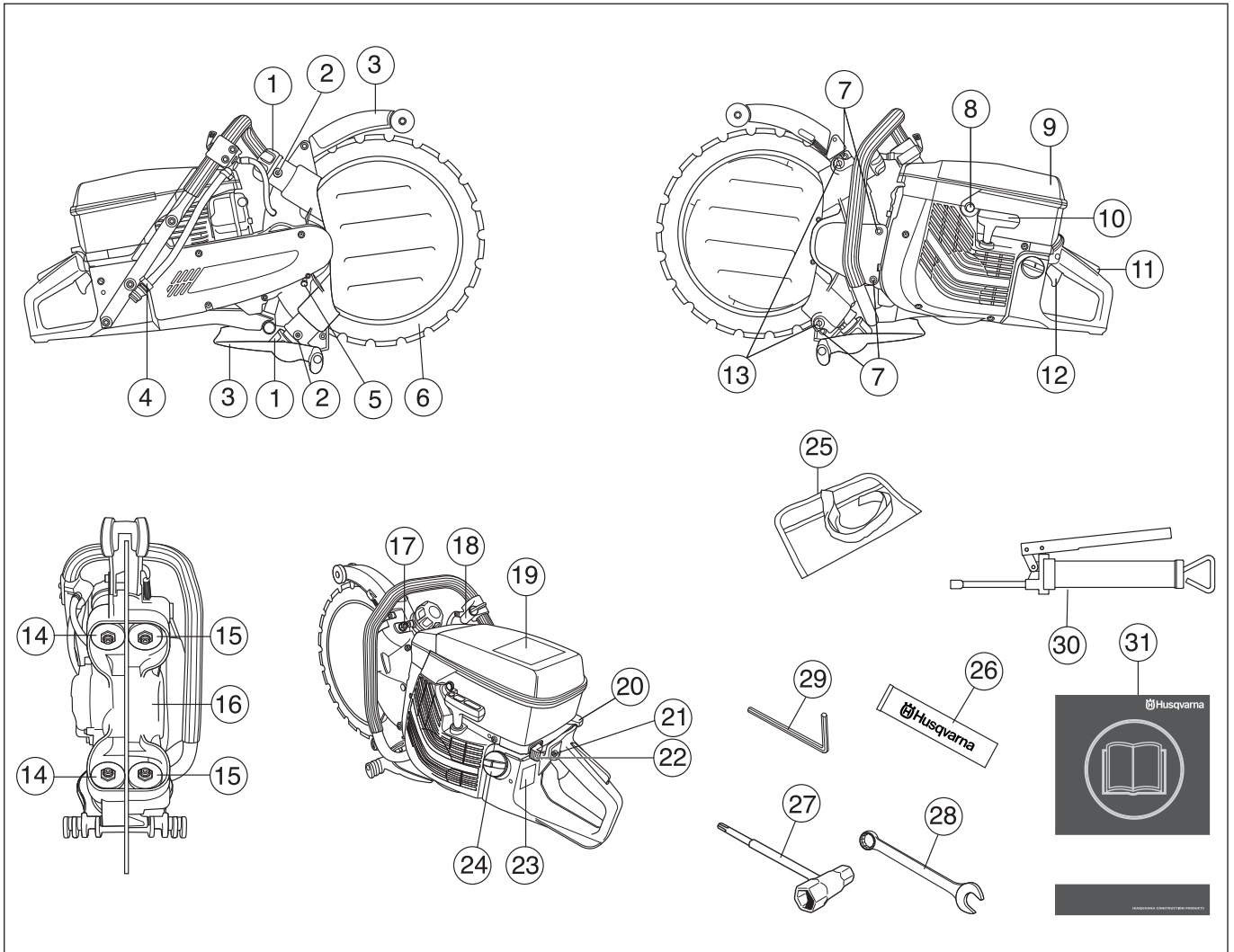

## What is what on the power cutter?

- |                                      |   |
|--------------------------------------|---|
| 1 Control for the guide rollers      | 17 Locking nuts for the support rollers |
| 2 Grease nipples                     | 18 Water tap                            |
| 3 Blade guard/spray guard            | 19 Warning decal                        |
| 4 Water connector                    | 20 Choke                                |
| 5 Locking button for the drive wheel | 21 Start throttle lock                  |
| 6 Diamond blade                      | 22 Stop switch                          |
| 7 Cover screws                       | 23 Type plate                           |
| 8 Decompression valve                | 24 Fuel tank                            |
| 9 Air filter cover                   | 25 Tool bag                             |
| 10 Starter handle                    | 26 Bearing grease                       |
| 11 Throttle lockout                  | 27 Combination spanner                  |
| 12 Throttle control                  | 28 19 mm combination spanner            |
| 13 Adjuster screws                   | 29 6 mm hex key                         |
| 14 Guide rollers                     | 30 Grease gun                           |
| 15 Support rollers                   | 31 Operator's manual                    |
| 16 Drive wheel                       |   |

# SAFETY INSTRUCTIONS

## Steps before using a new power cutter

- Please read the operator's manual carefully and make sure you understand the instructions before using the machine.
- Check the cutting blade's mounting, see the chapter "Assembly".
- Start the engine and check the idling setting, see instructions under the heading Maintenance. When the carburettor is set correctly the cutting blade should be still while idling. Setting of the idle speed is described in the Operator's Manual. Set the correct speed according to these instructions. Do not use the power cutter if the idle speed is not adjusted correctly!
- Let your Husqvarna dealer regularly check the power cutter and make essential adjustments and repairs.



**WARNING!** Under no circumstances may the design of the machine be modified without the permission of the manufacturer. Always use genuine accessories. Non-authorized modifications and/or accessories can result in serious personal injury or the death of the operator or others.



**WARNING!** Use of products which cut, grind, drill, sand or shape material can generate dust and vapors which may contain harmful chemicals. Know the nature of the material being worked on and wear appropriate dust mask or respirator protection.



**WARNING!** A power cutter is a dangerous tool if used carelessly or incorrectly and can cause serious, even fatal injuries. It is extremely important that you read and understand the contents of this Operator's Manual.



**WARNING!** The ignition system of this machine produces an electromagnetic field during operation. This field may under some circumstances interfere with pacemakers. To reduce the risk of serious or fatal injury, we recommend persons with pacemakers to consult their physician and the pacemaker manufacturer before operating this machine.

Husqvarna Construction Products has a policy of continuous product development. Husqvarna reserves the right to modify the design and appearance of products without prior notice and without further obligation introduce design modifications.

All information and all data in the Operator's Manual were applicable at the time the Operator's Manual was sent to print.



## WARNING

The engine exhaust from this product contains chemical known to the State of California to cause cancer, birth defects or other reproductive harm.

You will find the following labels on your power cutter:



The Emissions Compliance Period referred to on the Emission Compliance label indicates the number of operating hours for which the engine has been shown to meet Federal emissions requirements. Category C = 50 hours, B = 125 hours, and A = 300 hours.

## Personal protective equipment



**WARNING!** You must use approved personal protective equipment whenever you use the machine. Personal protective equipment cannot eliminate the risk of injury but it will reduce the degree of injury if an accident does happen. Ask your dealer for help in choosing the right equipment.

- Protective helmet
- Hearing protection
- Protective goggles or a visor



- Breathing mask

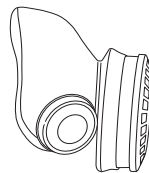

- Heavy-duty, firm grip gloves.

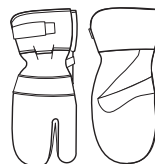

- Tight-fitting, heavy-duty and comfortable clothing that permits full freedom of movement.



# SAFETY INSTRUCTIONS

- Use leg-guards recommended for the material to be cut.
- Boots with steel toe-caps and non-slip sole



- Always have a first aid kit nearby.



## General safety precautions

**IMPORTANT!** Do not use the power cutter until you have read the entire contents of this Operator's Manual. All servicing, in addition to the points listed in the section "Control, maintenance and service of the power cutter's safety equipment", should be carried out by trained service specialists.

## Work area safety

- Keep work area clean and well lit. Cluttered or dark areas invite accidents.
- Do not use the machine in bad weather, such as dense fog, rain, strong wind, intense cold, etc. Working in bad weather is tiring and often brings added risks, such as icy ground.
- Never start to work with the power cutter before the working area is clear and you have a firm foothold. Look out for any obstacles with unexpected movement. Ensure when cutting that no material can become loose and fall, causing operating injury. Take great care when working on sloping ground.
- Make sure that no pipes or electrical cables are routed in the area to be cut.
- Look around you:
  - To ensure that people, animals or other things cannot affect your control of the machine.
  - To make sure that none of the above come into contact with the cutting blade.



**WARNING!** Only use the machine in areas with good ventilation. Neglect can result in serious injury or death.



**WARNING!** The safety distance for the power cutter is 15 metres. You are responsible to ensure that animals and onlookers are not within the working area. Do not start cutting until the working area is clear and you are standing firmly.

## Personal safety

- Wear personal protective equipment. See instructions under the heading Personal protective equipment.
- Never use the machine if you are tired, if you have consumed alcohol, or if you are taking other drugs or medication that can affect your vision, judgement or co-ordination.
- Never allow anyone else to use the machine without first ensuring that they have understood the contents of the operator's manual.
- Make sure that no clothes or parts of the body come in contact with the cutting equipment when it is rotating.
- Keep at a safe distance from the cutting equipment when it is rotating.
- The guards for the cutting equipment must always be fitted when the machine is running.
- Always ensure you have a safe and stable working position.



**WARNING!** Overexposure to vibration can lead to circulatory damage or nerve damage in people who have impaired circulation. Contact your doctor if you experience symptoms of overexposure to vibration. These symptoms include numbness, loss of feeling, tingling, pricking, pain, loss of strength, changes in skin colour or condition. These symptoms normally appear in the fingers, hands or wrists.

## Use and care

- A power cutter is designed to cut hard materials, such as masonry. Observe the increased risk of kickback when cutting soft materials. See instructions under the heading How to avoid kickback.
- Never use a machine that is faulty. Carry out the checks, maintenance and service instructions described in this manual. Some maintenance and service measures must be carried out by trained and qualified specialists. See instructions under the heading Maintenance.
- Never use a machine that has been modified in any way from its original specification.
- Do not move the machine when the cutting equipment is rotating.

**IMPORTANT!** K960 Ring may only be used for wet cutting. The water cleans and cools both the blade and the component parts of the cutting equipment.

**IMPORTANT!** Never work with a power cutter that is damaged or incorrectly adjusted. Check that the blade stops rotating when the throttle is released.

## Transport and storage

Do not store or transport the power cutter with the blade fitted.

Store the power cutter in a lockable area so that it is out of reach of children and unauthorised persons.

The blade should be removed from the machine after use and stored well. Store the blade in the dry.

# SAFETY INSTRUCTIONS

## Fuel safety



### (Refuelling/Fuel mixture/Storage.)



**WARNING! Take care when handling fuel. Bear in mind the risk of fire, explosion and inhaling fumes.**

- Never refuel the machine while the engine is running.
- Make sure there is plenty of ventilation when refuelling or mixing fuel (gasoline and 2-stroke oil).
- Move the machine at least 10 ft (3 m) from the refuelling point before starting it.

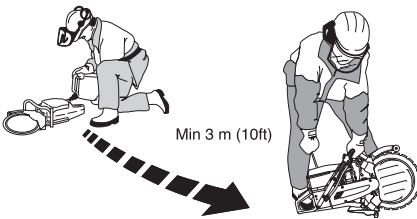

- Never start the machine:
  - If you have spilled fuel on it. Wipe off the spillage and allow remaining fuel to evaporate.
  - If you have spilled fuel on yourself or your clothes, change your clothes. Wash any part of your body that has come in contact with fuel. Use soap and water.
  - If the machine is leaking fuel. Check regularly for leaks from the fuel cap and fuel lines.
- Store and transport the machine and fuel so that there is no risk of any leakage or fumes coming into contact with sparks or naked flames, for example, from electrical machinery, electric motors, electrical relays/switches or boilers.
- Always store fuel in an approved container designed for that purpose.
- When storing the machine for long periods the fuel tank must be emptied. Contact your local gas station to find out where to dispose of excess fuel.
- Always use a Husqvarna fuel container with an anti-spill valve.



**WARNING! Bear in mind the risk of fire, explosion and inhaling fumes. Stop the engine before fuelling. Do not fill so that the fuel runs over. Wipe up all spillage on the ground and machine. If you spill fuel on yourself or your clothes. Change your clothes. Move the machine at least 3 metres away from the refuelling area before starting.**

## Machine's safety equipment

This section describes the machine's safety equipment, its purpose, and how checks and maintenance should be carried out to ensure that it operates correctly. See the "What is what?" section to locate where this equipment is positioned on your machine.



**WARNING! Never use a machine that has faulty safety equipment! Carry out the inspection, maintenance and service routines listed in this section.**

### Vibration damping system

Your machine is equipped with a vibration damping system that is designed to reduce vibration and make operation easier.

The machine's vibration damping system reduces the transfer of vibration between the engine unit/cutting equipment and the machine's handle unit.

The engine body, including the cutting equipment, is insulated from the handles by vibration damping units.

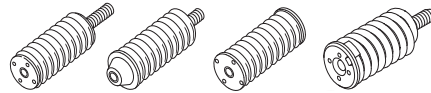

### Stop switch

Use the stop switch to switch off the engine.

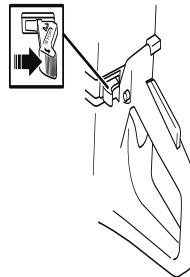

### Muffler



**WARNING! The muffler gets very hot in use and remains so for a short time afterwards. Do not touch the muffler if it is hot!**

The muffler is designed to keep noise levels to a minimum and to direct exhaust fumes away from the user.



**WARNING! The exhaust fumes from the engine are hot and may contain sparks which can start a fire. Never start the machine indoors or near combustible material!**



# SAFETY INSTRUCTIONS

**IMPORTANT!** For mufflers it is very important that you follow the instructions on checking, maintaining and servicing your machine. See instructions under the heading Checking, maintaining and servicing the machine's safety equipment.



**WARNING!** The inside of the muffler contain chemicals that may be carcinogenic. Avoid contact with these elements in the event of a damaged muffler.

## Throttle lockout

The throttle trigger lock is designed to prevent accidental operation of the throttle. When the lock (A) is pressed in this releases the throttle (B).

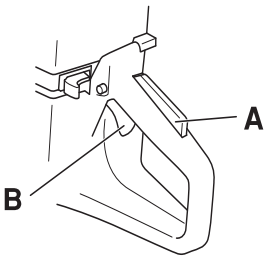

The trigger lock remains pressed in as long as the throttle is pressed.

When the grip on the handle is released the throttle trigger and the throttle trigger lock both return to their original positions. This is controlled by two independent return spring systems. This means that the throttle trigger is automatically locked in the idle position.

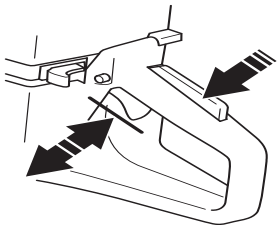

## Blade guard



**WARNING!** Always check that the guard is correctly fitted before starting the machine.

This guard is fitted above the blade and is designed to prevent parts of the blade or cutting fragments from being thrown towards the user.

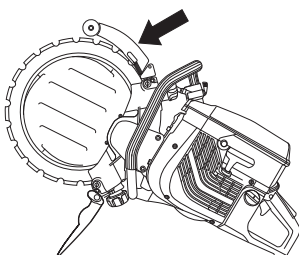



# SAFETY INSTRUCTIONS

## Checking, maintaining and servicing the machine's safety equipment



**WARNING!** All servicing and repair work on the machine requires special training. This is especially true of the machine's safety equipment. If your machine fails any of the checks described below you must contact your service agent. When you buy any of our products we guarantee the availability of professional repairs and service. If the retailer who sells your machine is not a servicing dealer, ask him for the address of your nearest service agent.

### Vibration damping system

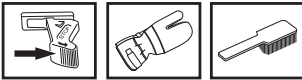

Regularly check the vibration damping units for cracks or deformation.

Make sure the vibration damping units are securely attached to the engine unit and handle unit.

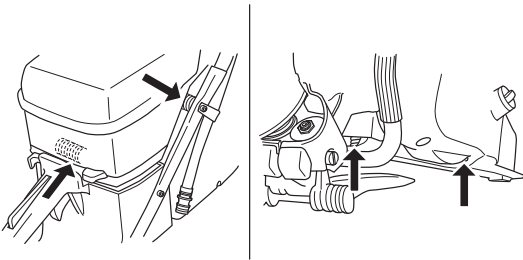

Keep the handles clean and dry.

### Stop switch

Start the engine and make sure the engine stops when you move the stop switch to the stop setting.

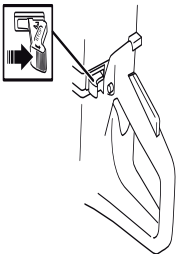

### Muffler

Never use a machine that has a faulty muffler.



Regularly check that the muffler is securely attached to the machine.



### Throttle lockout

- Make sure the throttle control is locked at the idle setting when the throttle lockout is released.

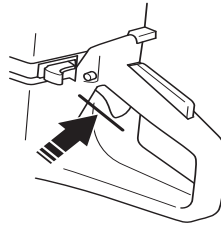

- Press the throttle lockout and make sure it returns to its original position when you release it.

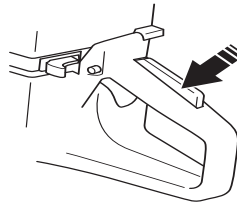

- Check that the throttle control and throttle lockout move freely and that the return springs work properly.

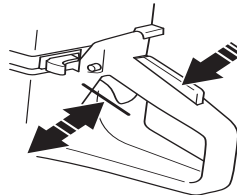

- Start the power cutter and apply full throttle. Release the throttle control and check that the cutting blade stops and remains stationary. If the cutting blade rotates when the throttle is in the idle position you should check the carburettor's idle adjustment.

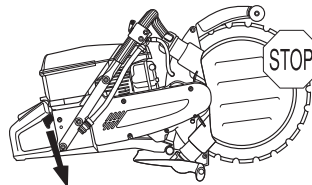

- See instructions under the heading Maintenance.

### Blade guard

Check that the guard is complete and without any cracks or deformations.

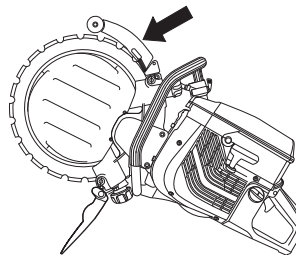

**WARNING!** Always check that the guard is correctly fitted before starting the machine. Also check that the blade is fitted correctly and is not damaged in anyway. A damaged blade can cause personal injuries. See instructions under the heading Assembly.

# SAFETY INSTRUCTIONS

## General working instructions



**WARNING!** This section describes basic safety directions for using a power cutter. This information is never a substitute for professional skills and experience. If you get into a situation where you feel unsafe, stop and seek expert advice. Contact your dealer, service agent or an experienced power cutter user. Do not attempt any task that you feel unsure of!

## Cutting technique

The technique described below is of a general character.

- Support the work piece in such a way that it is possible to predict what will happen, and so that the cut remains open while cutting.

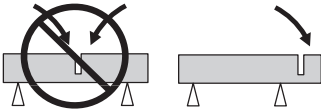

- Always hold the machine in a firm grip with both hands. Hold it so that the thumbs and fingers grip round the handles.
- Check that the blade is not in contact with anything when the machine is started.
- Start cutting with the machine running at maximum speed.
- Start cutting smoothly, allowing the machine to work without forcing or pressing in the blade.

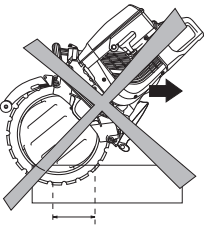

- Always cut at maximum speed.
- Move the blade slowly backwards and forwards to give a small contact surface between the blade and material to be cut. This will mean the blade temperature is kept down resulting in efficient cutting.

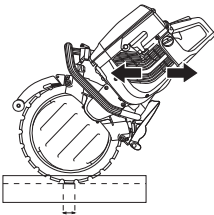

- Use a small part of the blade's cutting area.

- Feed the machine in line with the blade. Side pressure can destroy the blade and is extremely dangerous.

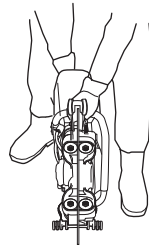

**WARNING!** Do not pull the power cutter to one side, this can cause the blade to jam or break resulting in injury to people.

## Cutting depth

K960 Ring can cut up to a depth of 260 mm (10 inches). Making a guide cut of 50-70 mm (2-3 inches) first, gives you better control of the machine. This means the water disc can penetrate into the workpiece and help control the machine. Attempting to saw the entire depth in one run takes longer. Working with several runs, 3 to 4 when the cut is 260 mm (10 inches) in depth, is much quicker.

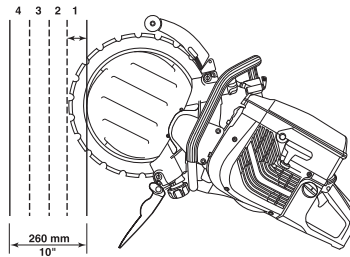

## Large work

Cuts exceeding 1 m - secure a batten along the line to be cut. The batten acts as a guide. Use this guide to make a marking cut along the entire length of the cut, 50-70 mm (2-3 inches) in depth. Remove the guides once the marking cut has been made.



## Small work

First make a shallow marking cut, max 50-70 mm (2-3 inches) in depth. Now make the final cut.

# SAFETY INSTRUCTIONS

## Cutting sequence

First make the lower horizontal cut. Now make the two vertical cuts. Finish with the upper horizontal cut.

Remember to divide the blocks up into manageable pieces so that they can be transported and lifted safely.

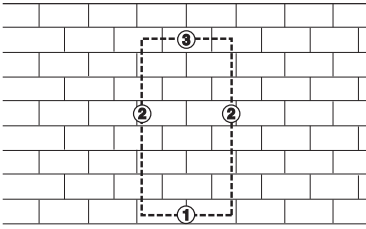

**CAUTION!** If the upper horizontal cut is made before the lower horizontal cut, the work piece will fall on the blade and jam it.

## How to avoid kickback



**WARNING!** Kickback can happen very suddenly and violently; kicking the power cutter and cutting blade back at the user. If this happens when the cutting blade is moving it can cause very serious, even fatal injuries. It is vital you understand what causes kickback and that you can avoid it by taking care and using the right working technique.

## What is kickback?

The word kickback is used to describe the sudden reaction that causes the power cutter and cutting blade to be thrown from an object when the upper quadrant of the blade, known as the kickback zone, touches an object.

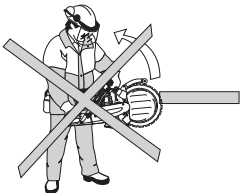

Kickback only occurs when the cutting blades kickback zone touches an object.

## General rules

- Never start to cut with the upper quadrant of the blade as shown in the figure, also known as the kickback zone.

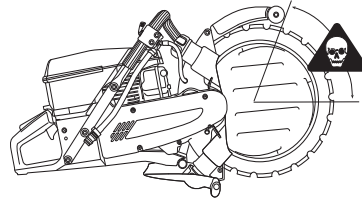

- Keep a good balance and a firm foothold.
- Always hold the machine in a firm grip with both hands. Hold it so that the thumbs and fingers grip round the handles.
- Stand at a comfortable distance from the work piece.
- Always cut at maximum speed.
- Take care when inserting the blade in an existing cut.
- Never cut above shoulder height.
- Be alert to movement of the work piece or anything else that can occur, which could cause the cut to close and pinch the blade.

## Pull in

Pull in occurs when the disc's lower section suddenly stops or when the cut closes. (To avoid, see the heading "Basic rules" and "Jamming/rotation", here below.)

## Pinching/rotation

If the cut is pressed together this can lead to jamming. The machine can be pulled down suddenly with a very powerful jerk.

## How to avoid pinching

Support the work piece in such a way that the cut remains open during the cutting operation and when the cut is finished.

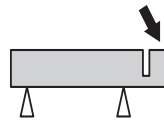

## Check the engine speed

Use a revolution counter regularly to check the engine speed at the working temperature, at full throttle and without a load.

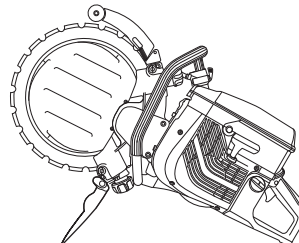

**WARNING!** The unit must be adjusted at an authorised service workshop before it may be used, if the speed is higher than that stated.

---

# SAFETY INSTRUCTIONS

---

## Diamond blades

Diamond blades consist of a steel body provided with segments that contain industrial diamonds.

Always use a sharp diamond blade. Sharpen the blade by cutting in a soft material such as sandstone or brick.

Diamond blades are available in several hardness classes. A "soft" diamond blade has a relatively short service life and large cutting capacity. It is used for hard materials such as granite and hard concrete. A "hard" diamond blade has a longer service life and reduced cutting capacity, and should be used for soft materials such as brick and asphalt.

Diamond blades are ideal for masonry, reinforced concrete and other composite materials. Diamond blades are not recommended for cutting metal.

## Water cooling



**WARNING! Cool diamond blades continuously with water to prevent overheating that can cause the diamond blade to break and pieces being thrown off resulting in injury and damage.**

Diamond blades should be sprinkled with water while cutting to cool the blade and to bind dust that forms while cutting.

## Sharpening diamond blades

Diamond blades can become dull when the wrong feeding pressure is used or when cutting certain materials such as heavily reinforced concrete. Working with a dull blade causes overheating and finally the loss of a segment (part of a cutting blade).

Sharpen the blade by cutting in a soft material such as sandstone or brick.

## Vibrations on diamond blades

The blade can become out of round and vibrate if a too high feed pressure is used.

A lower feed pressure can stop the vibration. Otherwise replace the blade. The blade shall be intended for the material to be cut.

# SETTINGS AND ADJUSTMENTS

## Drive

On account of the machine's unique design the driving power is not transferred at the centre of the blade. The flanges on the two guide rollers run in the blade's groove. Springs on the guide rollers press out the rollers, which in turn press the V-shaped edge on the inside diameter of the blade against the V-shaped groove in the drive wheel. The drive wheel is fitted on an axle which is driven by the engine via a drive belt. This allows a total cutting depth of 260 mm (10 inches) with a 350 mm (14 inches) diamond blade.

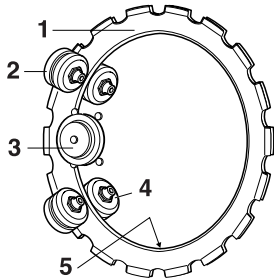

- 1 Blade
- 2 Support rollers
- 3 Drive wheel
- 4 Guide rollers
- 5 V-shaped edge

## Checking wear

As the blade is used the inside diameter and the groove in the drive wheel become worn.

The ring cutter will also work well in the future if:

- the drive wheel is not too worn
  - A) New
  - B) Worn
- the guide rollers are not too worn
  - A) New
  - B) Worn

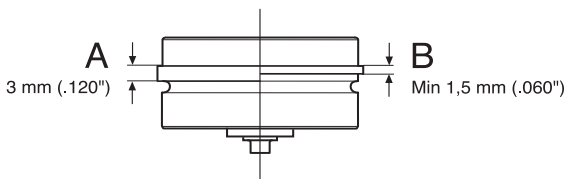
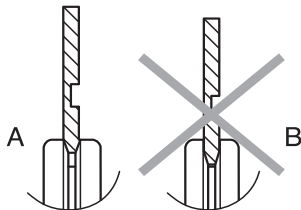

- adjustment between the rollers and blade is correct.
- The roller setting should be checked twice during the life of the diamond blade, once after fitting the blade and when the blade is semi worn.

## Fitting the blade

We offers a number of blades for different materials in its range. Check with your Husqvarna dealer to see which blades are best suited for your usage.

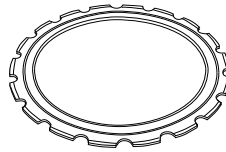

**WARNING!** It is forbidden to reconstruct a used blade. A used blade may be weakened. A reconstructed blade can crack or break into pieces and seriously injure the operator or other persons.

- Wipe off any dirt from the surface of the blade.

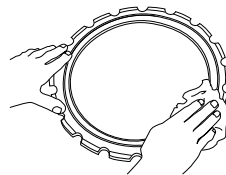

- Loosen the locking nuts on the support roller cover.

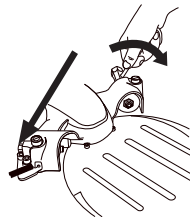

- Unscrew the adjuster screws a few turns.

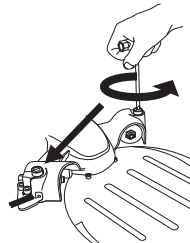

- Loosen the knob to offload the springs.

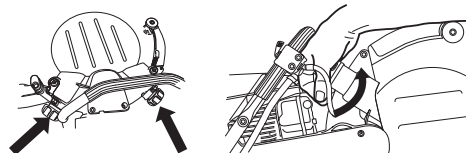

- Remove the four screws holding the support roller guard using a 6 mm hex key and lift off the cover.

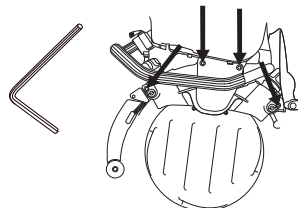

**WARNING!** Check that the blade is not damaged before fitting it on the machine. Damaged blades can disintegrate and cause serious personal injury.

# SETTINGS AND ADJUSTMENTS

- Fit the blade.

**CAUTION!** The blade has a groove (A) on one side that acts as the guide groove for the support rollers. Ensure that the V-shaped edge of the blade enters the drive wheel and that the blade's guide groove fits in the guide rollers. Also see under the heading Drive.

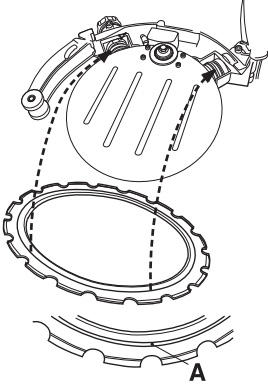

- Press in the guide roller if necessary, so that it climbs into the groove on the blade.

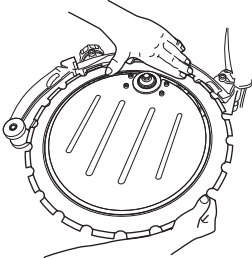

- Fit the support roller cover. Now tighten the four screws fully.

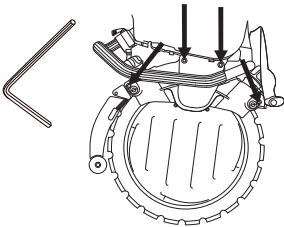

- Rotate the blade and make sure that the support rollers are not clamped against the blade.

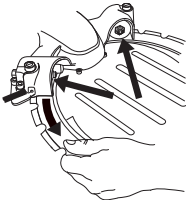

- Adjust the adjuster screws so that the support rollers make contact against the blade.

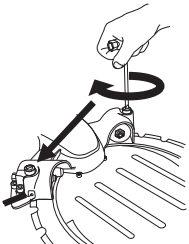

- Adjust so you can easily stop the support rollers using your thumb when the blade is rotated. The support rollers should only follow the blade occasionally.

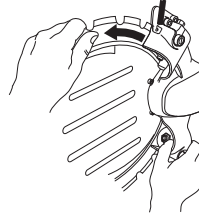

- Tighten the locking nuts on the support roller guard.

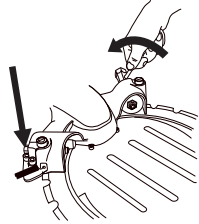

- Rotate the blade and make sure you can still hold the rollers with your thumb when the blade is rotated.

**CAUTION!** The machine shall stand upright when checking the roll pressure. If the machine lies on its side the weight of the blade makes it difficult to make a correct adjustment.

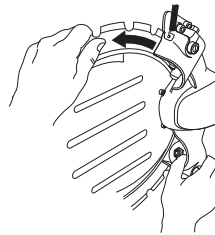

- Tighten the knobs fully and the machine is ready to use.

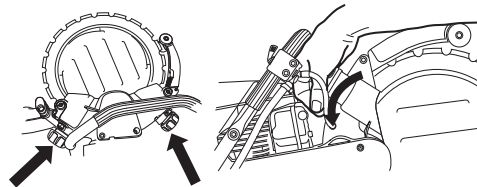



# SETTINGS AND ADJUSTMENTS

## Dismantling the complete guide roller

- Remove the support roller cover.

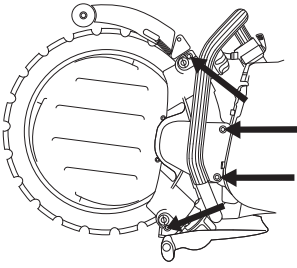

- Lift off the blade.

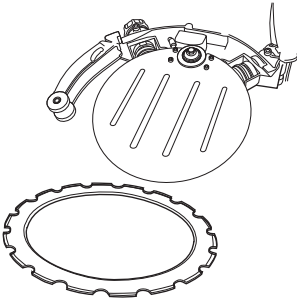

- Unscrew the knob. First turn the knob a few turns until you feel a resistance. The guide roller then follows the knob out and stops when it feels a resistance.

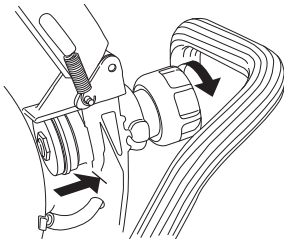

The guide roller is pressed into the knob. In order to loosen the guide roller, you need to continue turning the knob until it loosens completely.

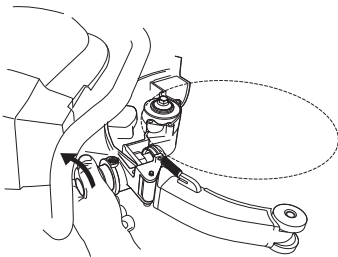

The guide roller can now be pulled out of the chassis

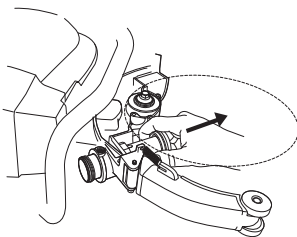

## Assembling the complete guide roller

- Screw the knob until it bottoms, and then loosen the knob 2 turns.

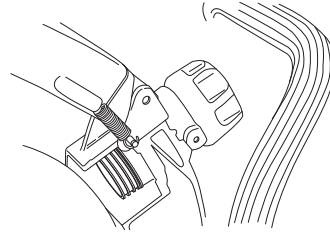

- Insert the guide roller in the chassis

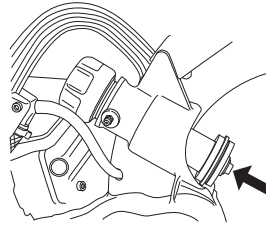

- Now press the guide roller into the knob.

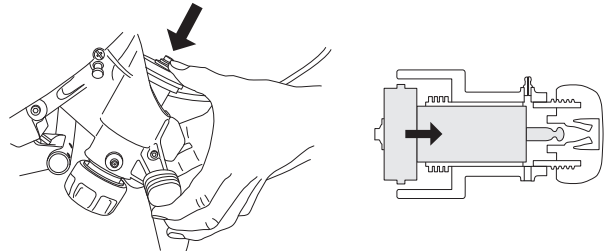

- Lubricate the guide roller's sleeve using grease. Fit the grease gun on the grease nipples (A) and pump in grease until clean grease emerges from the overflow hole (B).

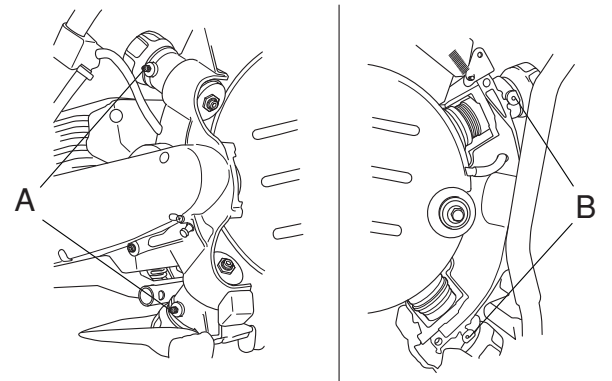

- Fit the blade. See the heading Fitting the blade.

### Important notes:

- Incorrect adjustment can result in damage to the blade.
- If the blade rotates slowly or stops, stop cutting immediately and trouble shoot.



# SETTINGS AND ADJUSTMENTS

## Replacing the drive wheel

- 1 Lock the axle using the locking button.
- 2 Loosen the centre screw and remove the washer.

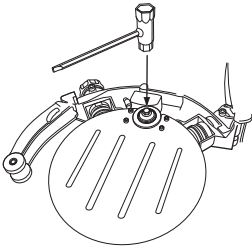

- 3 You can now lift off the drive wheel.

**CAUTION!** Replace the drive wheel when fitting a new blade. A worn drive wheel can result in the blade slipping and becoming damaged.

Inadequate water flow drastically shortens the life of the drive wheel.

## Replacing the support rollers/guide rollers

- Remove the support roller cover.
- Check the rollers for wear.
- Use a 19 mm fixed spanner and a 13 mm combination spanner to replace the rollers.

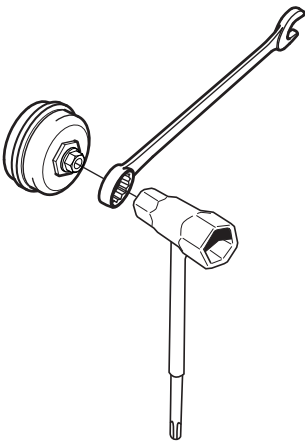

- Lubricate using bearing grease inside the rollers before the new rollers are fitted.

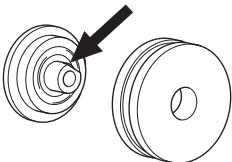

- Replace the guide rollers when half of the flange on the rollers is worn.

- A) New
- B) Worn

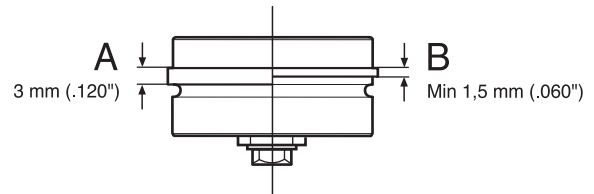

- Replace the support rollers when the roller surface is flat, (or) when the groove on the roller surface has worn away.

- A) New
- B) Worn

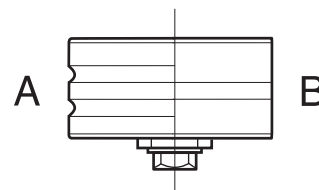

## Water hose

Connect the water hose to the water supply. The water flow is activated by opening the check valve. Minimum water flow: 4 l/min Note that the machine's hose nipple is fitted with a filter.

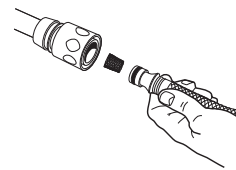

# FUEL HANDLING

## Fuel

CAUTION! The machine is equipped with a two-stroke engine and must always be run using a mixture of gasoline and two-stroke engine oil. It is important to accurately measure the amount of oil to be mixed to ensure that the correct mixture is obtained. When mixing small amounts of fuel, even small inaccuracies can drastically affect the ratio of the mixture.



**WARNING! Always ensure there is adequate ventilation when handling fuel.**

## Gasoline

- The lowest recommended octane grade is 87 ((RON+MON)/2). If you run the engine on a lower octane grade than 87 so-called knocking can occur. This gives rise to a high engine temperature and increased bearing load, which can result in serious engine damage.

## Two-stroke oil

- For best results and performance use HUSQVARNA two-stroke engine oil, which is specially formulated for our air-cooled two stroke-engines.
- Never use two-stroke oil intended for water-cooled outboard engines, sometimes referred to as outboard oil.
- Never use oil intended for four-stroke engines.

## Mixing ratio

Gasoline, litre	Two-stroke oil, litre
	<b>2% (1:50)</b>
5	0,10
10	0,20
15	0,30
20	0,40
US gallon	US fl. oz.
1	2 1/2
2 1/2	6 1/2
5	12 7/8

## Mixing

- Always mix the gasoline and oil in a clean container intended for fuel.
- Always start by filling half the amount of the gasoline to be used. Then add the entire amount of oil. Mix (shake) the fuel mixture. Add the remaining amount of gasoline.
- Mix (shake) the fuel mixture thoroughly before filling the machine's fuel tank.

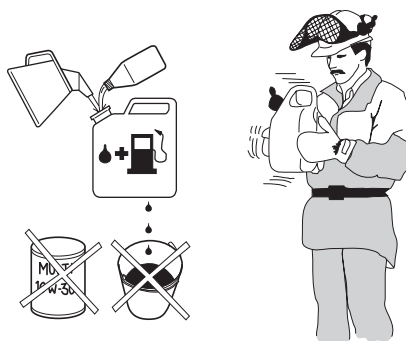

- Do not mix more than one month's supply of fuel at a time.
- If the machine is not used for some time the fuel tank should be emptied and cleaned.

## Fueling



**WARNING! Taking the following precautions, will lessen the risk of fire:**

- Do not smoke or place hot objects near fuel.**
- Always shut off the engine before refuelling.**
- When refuelling, open the fuel cap slowly so that any excess pressure is released gently.**
- Tighten the fuel cap carefully after refuelling.**
- Always move the machine away from the refuelling area before starting.**

- Keep the handle dry and free from oil and fuel.
- Clean around the fuel cap. Clean the fuel tank regularly. The fuel filter should be changed at least once a year. Contamination in the tank causes malfunction.

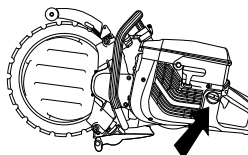

- Ensure that the fuel is well mixed by shaking the container before filling the tank.



- Always exercise care when refilling the fuel. Move the machine at least three metres from the fuelling area before it is started. Check that the fuel cap is tightened correctly.

# STARTING AND STOPPING

## Before starting



**WARNING! Note the following before starting:**

Do not start the power cutter without the belt guard fitted. Otherwise the clutch could come loose and cause personal injuries.

Always move the machine away from the refuelling area before starting.

Ensure that you and the machine have a good working stance and that the cutting blade can rotate freely.

Keep people and animals well away from the working area.

**Decompression valve:** Press the valve to reduce the compression in the cylinder. The decompression valve should always be used when starting. The valve automatically returns to its initial position when the machine starts.

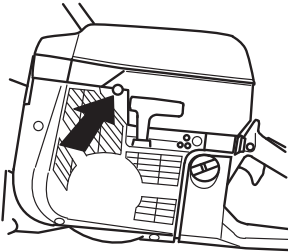

**Stop switch:** Make sure that the stop switch (STOP) is in the left position.

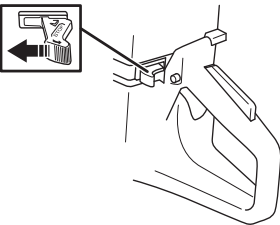

**Start throttle position - cold engine:** Start throttle position and choke is obtained by pulling out the choke completely.

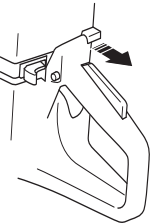

**Start throttle position - warm engine:** The correct choke/start throttle setting is obtained by pulling the choke control to the choke position and then pushing it in again. This only engages the start throttle setting without any choke.

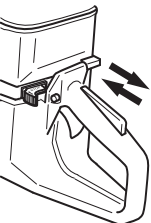

## Starting

Grip the front handle with your left hand. Put your right foot on the lower section of the rear handle pressing the machine against the ground. **Never wrap the starter cord around your hand**

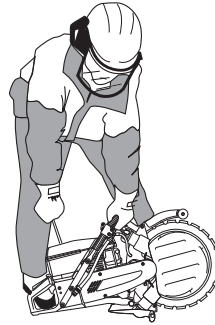

**WARNING! The cutting blade rotates when the engine is started. Make sure it can rotate freely.**

Grip the starter handle, slowly pull out the cord with your right hand until you feel some resistance (the starter pawls grip), now quickly and powerfully pull the cord.

**CAUTION!** Do not pull the starter cord all the way out and do not let go of the starter handle when the cord is fully extended. This can damage the machine.

With a cold engine: Push in the choke control as soon as the engine fires and make repeated starting attempts.

When the engine starts, quickly apply full throttle to automatically disengage fast idle.

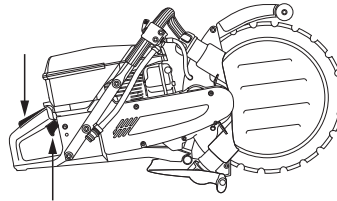

## Stopping

Stop the engine by moving the stop switch (STOP) to the right.

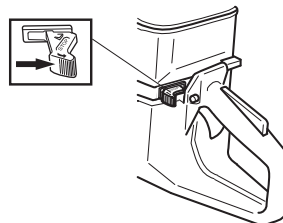

# MAINTENANCE

## Lubricating the guide rollers

- Connect the grease gun to the grease nipples.

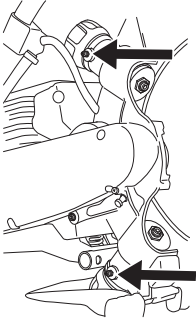

- Pump in grease until clean grease emerges from the overflow hole.

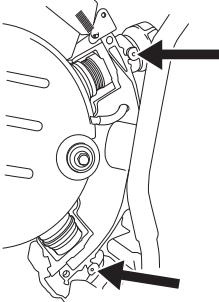

## Adjusting the drive belt

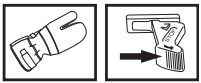

The drive belt is fully enclosed and well-protected from dust, dirt and mechanical damage when cutting.

- Dismantle the cover and loosen the belt tensioning screw.

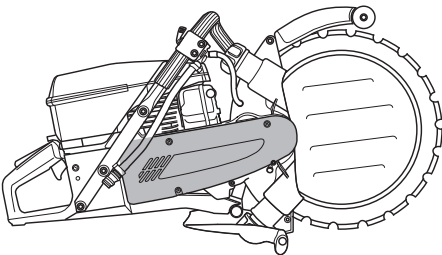

- Press on the belt tensioner with your thumb to tension the belt. Now tighten the screw holding the belt tensioner.

## Belt tensioning/replacing the drive belt



- Dismantle the cover and loosen the belt tensioning screw. Push back the belt tensioning roller and install a new drive belt.

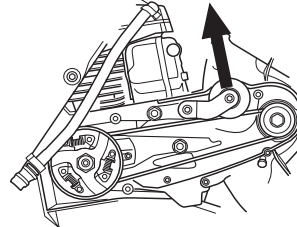

**CAUTION!** Make sure that both belt pulleys are clean and undamaged before a new drive belt is fitted.

- Press on the belt tensioner with your thumb to tension the belt. Now tighten the screw holding the belt tensioner.

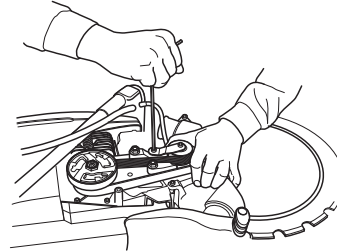

- Fit the belt cover.

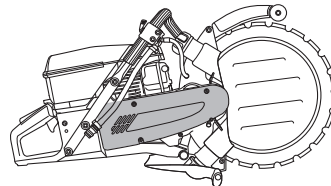

**WARNING!** Never use the power cutter without a blade guard over the cutting blade.

## Belt pulley and clutch

Never start the engine when the belt pulley and clutch are removed for maintenance.

# MAINTENANCE

## Carburetor

Your Husqvarna product has been designed and manufactured to specifications that reduce harmful emissions. After the engine has used 8-10 tanks of fuel the engine will be run-in. To ensure that it continues to run at peak performance and to minimise harmful exhaust emissions after the running-in period, ask your dealer/service workshop (who will have a rev counter at their disposal) to adjust your carburettor.

### Function



**WARNING! Do not start the machine without the cutting arm or cutting head fitted. Otherwise the clutch could come loose and cause personal injuries.**

- The carburettor governs the engine speed via the throttle. Air and fuel are mixed in the carburettor.

### Needles

The carburettor is equipped with fixed needles to ensure the machine always receives the correct mixture of fuel and air. When the engine lacks power or accelerates poorly, do the following:

- Check the air filter and replace if necessary.
- When this does not help, contact an authorised service workshop.

### Adjusting the idle speed (T)

Adjust the idle speed using the T screw. When an adjustment is necessary, first turn the screw clockwise until the blade starts to rotate. Now turn the screw anti-clockwise until the blade stops rotating. A correctly adjusted idle speed is set when the engine accelerates without hesitation.

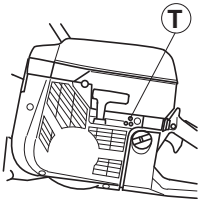

Rec. idle speed: 2500 rpm



**WARNING! If the idle speed cannot be adjusted so that the cutting attachment stops, contact your dealer/service workshop. Do not use the machine until it has been correctly adjusted or repaired.**

## Fuel filter

- The fuel filter sits inside the fuel tank.
- The fuel tank must be protected from contamination when filling. This reduces the risk of operating disturbances caused by blockage of the fuel filter located inside the tank.
- The filter cannot be cleaned but must be replaced with a new filter when it is clogged. **The filter should be changed at least once per year.**

## Air filter



Air filters must be regularly cleaned to remove dust and dirt in order to avoid:

- Carburettor malfunctions
- Starting problems
- Loss of engine power
- Unnecessary wear to engine parts
- Excessive fuel consumption.

The air filter system consists of an oiled foam plastic filter (1) and a paper filter (2):

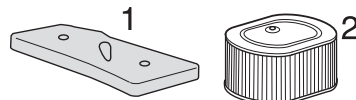

- 1 The foam plastic filter is easily accessible under the filter cover A. This filter should be checked weekly and replaced if necessary.

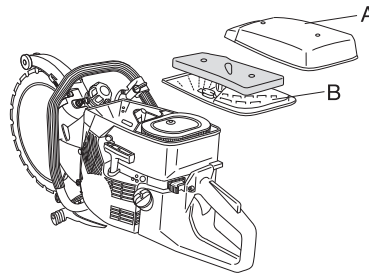

In order to obtain a good filtering effect, the filter must be replaced regularly or cleaned and oiled. A special HUSQVARNA oil has been produced for this purpose.

Remove the foam plastic filter. Wash the filter well in tepid soapy water. After cleaning, rinse the filter well in clean water. Squeeze out and allow the filter to dry. **NOTE!** High pressure compressed air can damage the foam.

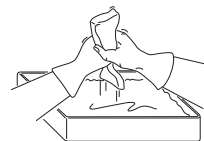

Put the filter in a plastic bag and pour the filter oil over it. Knead the plastic bag to distribute the oil. Squeeze the excess oil out of the filter inside the plastic bag and pour off the excess before fitting the filter to the machine. Never use common engine oil. This would drain through the filter quite quickly and collect in the bottom.

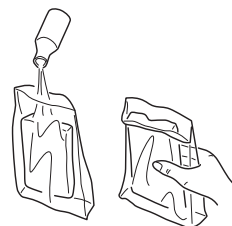

# MAINTENANCE

- The paper filter is accessible under cover B. This filter must be replaced/cleaned when the engine's power drops. The filter is cleaned by shaking. Note that the filter must not be washed. **NOTE!** High pressure compressed air can damage the filter.

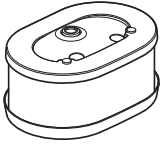

An air filter that has been in use for a long time cannot be cleaned completely. The filter must therefore be replaced with a new one at regular intervals. **A damaged air filter must always be replaced.**

**IMPORTANT!** Poor maintenance of the air filter will cause carbon build-up on the spark plug and abnormal wear to engine parts.

## Starter



**WARNING!** When the recoil spring is wound up in the starter housing it is under tension and can, if handled carelessly, pop out and cause personal injury.

**Always be careful when changing the recoil spring or the starter cord. Always wear protective goggles.**

## Changing a broken or worn starter cord



- Loosen the screws that hold the starter against the crankcase and remove the starter.

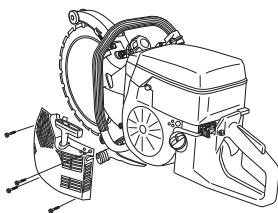

Pull the cord out about 30 cm and lift it into the cut-out in the periphery of the starter pulley. When the cord is intact: Release the spring tension by letting the pulley rotate slowly backwards.

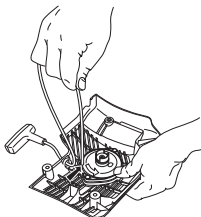

- Remove any remnants of the old starter cord and check that the return spring works. Insert the new starter cord through the hole in the starter housing and in the cord pulley.

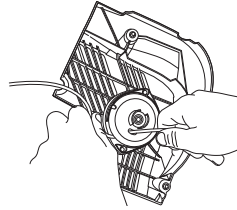

- Secure the starter cord around the cord pulley as illustrated. Tighten the fastening well and ensure that the free end is as short as possible. Secure the end of the starter cord in the starter handle.

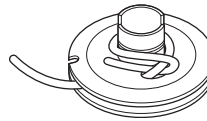

Guide the cord through the cut-out in the periphery of the pulley and wind the cord 3 times clockwise around the centre of the starter pulley.

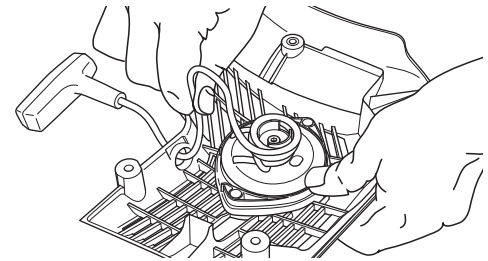

Now pull the starter handle and in doing so tension the spring. Repeat the procedure once more, but this time with four turns.

Note that the starter handle is drawn to its correct home position after tensioning the spring.

Check that the spring is not drawn to its end position by pulling out the starter line fully. Slow the starter pulley with your thumb and check that you can turn the pulley at least a further half turn.

## Tensioning the recoil spring

- Hook the starter cord in the notch in the pulley and turn the starter pulley about 2 turns clockwise.

Remove the cord from the cut-out on the starter pulley and offload the spring tension by letting the pulley slowly rotate backwards.

**CAUTION!** Check that the pulley can be turned an additional 1/2 turn when the starter cord is pulled all the way out.

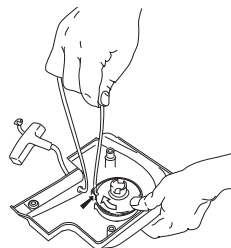



# MAINTENANCE

## Changing a broken recoil spring



- Loosen the screws that hold the starter against the crankcase and remove the starter.

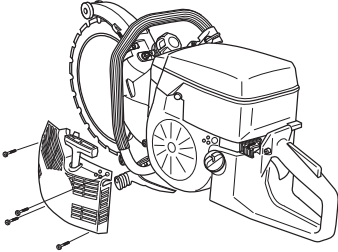

- Undo the bolt in the centre of the pulley and remove the pulley.

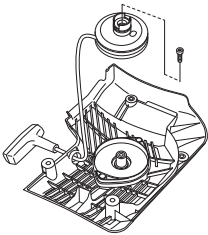

- Loosen the bolts holding the spring cassette.

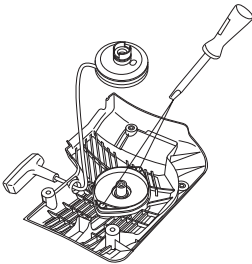

- Remove the recoil spring by turning the starter over and loosen the hooks, with the help of a screwdriver. The hooks hold the return spring assembly on the starter.

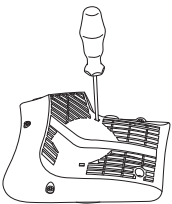

Bear in mind that the return spring lies tensioned in the starter housing. If the spring flies out during assembly, it is wound working from the outside towards the centre.

- Lubricate the recoil spring with light oil. Fit the pulley and tension the recoil spring.

## Fitting the starter

- To fit the starter, first pull out the starter cord and place the starter in position against the crankcase. Then slowly release the starter cord so that the pulley engages with the pawls.

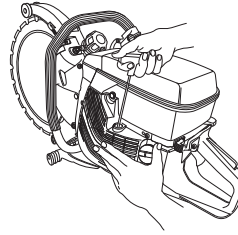

- Fit and tighten the screws that hold the starter.

## Spark plug



The spark plug condition is influenced by:

- Incorrect carburetor adjustment.
- Wrong fuel mixture (too much oil).
- A dirty air filter.

These factors cause deposits on the spark plug electrodes, which may result in operating problems and starting difficulties.

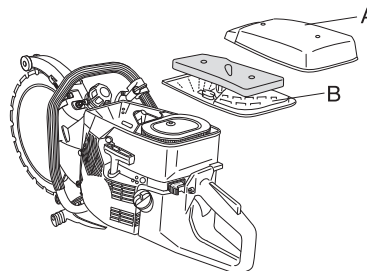

- If the machine is low on power, difficult to start or runs poorly at idle speed: always check the spark plug first before taking any further action. If the spark plug is dirty, clean it and check that the electrode gap is 0.020 inch (0.5 mm). The spark plug should be replaced after about a month in operation or earlier if necessary.

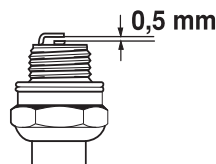

**CAUTION!** Always use the recommended spark plug type! Use of the wrong spark plug can damage the piston/cylinder.



# MAINTENANCE

## Cooling system

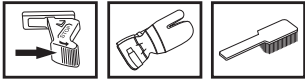

To keep the working temperature as low as possible the machine is equipped with a cooling system.

The cooling system consists of:

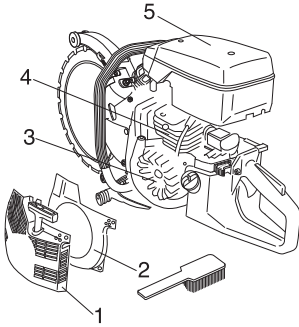

- 1 Air intake on the starter.
- 2 Air guide plate.
- 3 Fins on the flywheel.
- 4 Cooling fins on the cylinder.
- 5 Cylinder cover

Clean the cooling system with a brush once a week, more often in demanding conditions. A dirty or blocked cooling system results in the machine overheating which causes damage to the piston and cylinder.

## Muffler



The muffler is designed to reduce the noise level and to direct the exhaust gases away from the operator. The exhaust gases are hot and can contain sparks, which may cause fire if directed against dry and combustible material.

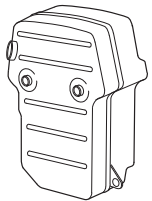

Never use a machine with a defective muffler.

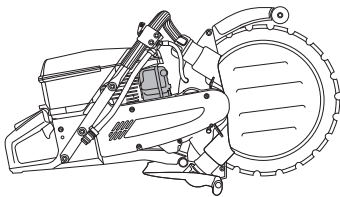

## Reconstructing the blade



**WARNING!** Ring cutter blades must not be reconstructed. Due to its design, a ring cutter blade is exposed to other strains than a centre driven 14 inch diamond blade. Firstly, the drive wheel is driven on the inner diameter of the blade so that both the surfaces of the drive wheel and the blade are exposed to wear. The core of the blade becomes thinner and the guide wider, which prevents the blade being driven by the wheel. Secondly, the blade is exposed to loads from the rollers and from the actual cutting process when the blade is not held completely straight. Strain builds up in the blade until it cracks or breaks if it has been reconstructed. A shattered blade can cause serious personal injuries to the user or other persons. For this reason Husqvarna does not approve ring cutting blades that have been reconstructed. Contact your Husqvarna dealer for instructions.

# MAINTENANCE

## General maintenance instructions

Below you will find some general maintenance instructions. If you have more questions, contact your service agent.

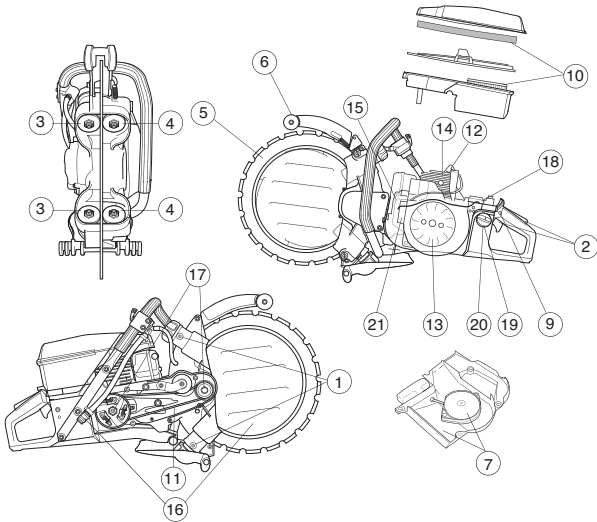

### Daily maintenance

- 1 Lubricate the guide rollers.
- 2 Check that the components of the throttle control work smoothly (throttle control and throttle trigger lock).
- 3 Check the guide rollers for wear when replacing the blade. Dismantle the complete guide roller. Clean and grease them for the best effect.
- 4 Check the support rollers for wear.
- 5 Check the condition of the blade and the drive gear.
- 6 Check the condition of the blade guard.
- 7 Check the starter and starter cord and clean the outside of the starter unit's air intake.
- 8 Check that nuts and screws are tight.
- 9 Check that the stop switch works correctly.

### Weekly maintenance

- 10 Check, clean or replace the main filter.
- 11 Check the tension of the drive belt.
- 12 Clean the spark plug. Check that the electrode gap is 0.020 inch (0.5 mm).
- 13 Clean the fins on the flywheel. Check the starter and the recoil spring.
- 14 Clean the cooling fins on the cylinder.
- 15 Check that the muffler is securely attached and not damaged.
- 16 Check and clean the water disc and water inlet screen.

### Monthly maintenance

- 17 Check the clutch centre, drive gear and clutch spring for wear.
- 18 Clean the outside of the carburetor.
- 19 Check fuel hose for cracks or other damage. Change if necessary.
- 20 Clean the inside of the fuel tank.
- 21 Check all cables and connections.

# MAINTENANCE

## Trouble shooting

### Mechanics

Symptom		Probable cause
The blade does not rotate.	1	Roller knobs not tightened fully.
	2	The blade not fitted on guide rollers correctly.
	3	Rollers tensioned too much.
The blade rotates too slowly.	1	Roller knobs not tightened fully.
	2	Worn drive wheel.
	3	The V-shaped inner diameter of the blade is worn.
	4	The springs on the guide rollers are weakened.
	5	Defective roller bearings.
The blade jumps out of its position.	1	Roller setting too loose.
	2	Worn guide rollers.
	3	The blade not fitted on guide rollers correctly.
	4	Damaged blade.
The blade warps.	1	Rollers tensioned too much.
	2	Blade overheating.
Segments break.	1	Bent, twisted or badly maintained blade.
	2	Continue to use the blade only if one segment is missing or leave for reconstruction when the blade is worn max 50 %.
The blade cuts too slowly.	1	Wrong blade for the material in question.
The blade slips.	1	The guide rollers does not move in and out freely. A seized roller can not press the blade hard enough against the drive wheel.
	2	Worn drive wheel. Abrasive material and too little water when cutting increases the wear on the wheel.
	3	Worn guide roller flange. When more than half of the width of the flange is worn the blade slips.
	4	The blade's groove and inner edge are worn. Caused by inferior flushing of abrasive material and/or a worn drive wheel causing the blade to slip.

---

# TECHNICAL DATA

---

## Technical data

### Engine

Cylinder displacement, cu.in/cm <sup>3</sup>	5,7/93,6
Cylinder bore, inch/mm	2,2/56
Stroke, inch/mm	1,50/38,0
Idle speed, rpm	2700
Recommended max. fast idle speed, rpm	9750 (+/- 250)
Power, kW/ rpm	4,5/9000

### Ignition system

Manufacturer of ignition system	SEM
Spark plug	Champion RCJ 6Y/ NGK BPMR 7A
Electrode gap, inch/mm	0,02/0,5

### Fuel and lubrication system

Manufacturer of carburetor	Walbro
Carburetor type	RWJ-3A
Fuel tank capacity, US pint/litre	2,11/1,0

### Weight

Power cutter without fuel and cutting blade, Lbs/kg	28,8/13,1
---	-----------

## Cutting equipment

Max. peripheral speed, m/s	2,2/55
Blade diameter, mm/inches	350/14"
Cutting depth, mm/inches	260/10"
Max. engine speed, rpm	10000
Blade weight, kg	0,8

### Dimensions

Height, mm	410
Length, mm	715
Width, mm	260
Water consumption, litres/min	4



# FEDERAL EMISSION CONTROL WARRANTY STATEMENT

## YOUR WARRANTY RIGHTS AND OBLIGATIONS

The EPA (The US Environmental Protection Agency), Environment Canada and Husqvarna Construction Products are pleased to explain the emissions control system warranty on your 2001 and later small nonroad engine. In U.S. and Canada, new small nonroad engines must be designed, built and equipped to meet the federal stringent anti-smog standards. Husqvarna Construction Products must warrant the emission control system on your small nonroad engine for the period of time listed below provided there has been no abuse, neglect or improper maintenance of your unit. Your emission control system includes Parts such as the carburetor and the ignition system. Where a warrantable condition exists, Husqvarna Construction Products will repair your small nonroad engine at no cost to you. Expenses covered under warranty include diagnosis, parts and labor.

## MANUFACTURER'S WARRANTY COVERAGE

The 2001 and later small nonroad engines are warranted for two years. If any emission related part on you engine (as listed above) is defective, the part will be repaired or replaced by Husqvarna Construction Products.

## OWNER'S WARRANTY RESPONSIBILITIES

As the small nonroad engine owner, you are responsible for the performance of the required maintenance listed in your Operator's Manual. Husqvarna Construction Products recommends that you retain all receipts covering maintenance on your small nonroad engine, but Husqvarna Construction Products cannot deny warranty solely for the lack of receipts or for your failure to ensure the performance of all scheduled maintenance. As the small nonroad engine owner, you should, however, be aware that Husqvarna Construction Products may deny you warranty coverage if your small nonroad engine or a part of it has failed due to abuse, neglect, improper maintenance, unapproved modifications or the use of parts not made or approved by the original equipment manufacturer. You are responsible for presenting your small nonroad engine to a Husqvarna Construction Products authorized servicing dealer as soon as a problem exists. The warranty repairs should be completed in a reasonable amount of time, not to exceed 30 days. If you have any questions regarding your warranty rights and responsibilities, you should contact your nearest authorized servicing dealer or call Husqvarna Construction Products, at 1-800-323 3553.

## WARRANTY COMMENCEMENT DATE

The warranty period begins on the date small nonroad engine is delivered.

## LENGTH OF COVERAGE

Husqvarna Construction Products warrants to the initial owner and each subsequent purchaser that the engine is free from defects in materials and workmanship which cause the failure of a warranted part for a period of two years.

## WHAT IS COVERED

**REPAIR OR REPLACEMENT OF PARTS** Repair or replacement of any warranted part will be performed at no charge to the owner at an approved Husqvarna Construction Products servicing dealer. If you have any questions

regarding your warranty rights and responsibilities, you should contact your nearest authorized servicing dealer or call Husqvarna Construction Products, at 1-800-323 3553.

**WARRANTY PERIOD** Any warranted part which is not scheduled for replacement as required maintenance, or which is scheduled only for regular inspection to the effect of "repair or replace as necessary" shall be warranted for 2 years. Any warranted part which is scheduled for replacement as required maintenance shall be warranted for the period of time up to the first scheduled replacement point for that part.

**DIAGNOSIS** The owner shall not be charged for diagnostic labor which leads to the determination that a warranted part is defective, if the diagnostic work is performed at an approved Husqvarna Construction Products servicing dealer.

**CONSEQUENTIAL DAMAGES** Husqvarna Construction Products may be liable for damages to other engine components caused by the failure of a warranted part still under warranty.

## WHAT IS NOT COVERED

All failures caused by abuse, neglect or improper maintenance are not covered.

## ADD -ON OR MODIFIED PARTS

The use of add-on or modified parts can be grounds for disallowing a warranty claim. Husqvarna Construction Products is not liable to cover failures of warranted parts caused by the use of add-on or modified parts.

## HOW TO FILE A CLAIM

If you have any questions regarding your warranty rights and responsibilities, you should contact your nearest authorized servicing dealer or call Husqvarna Construction Products, at 1-800-323 3553.

## WHERE TO GET WARRANTY SERVICE

Warranty services or repairs shall be provided at all Husqvarna Construction Products authorized servicing dealers.

## MAINTENANCE, REPLACEMENT AND REPAIR OF EMISSION-RELATED PARTS

Any Husqvarna Construction Products approved replacement part used in the performance of any warranty maintenance or repairs on emission-related parts, will be provided without charge to the owner if the part is under warranty.

## EMISSION CONTROL WARRANTY PARTS LIST

- 1 Carburetor and internal parts
- 2 Intake pipe, airfilter holder and carburetor bolts.
- 3 Airfilter and fuelfilter covered up to maintenance schedule.
- 4 Ignition System
  - 1 Spark Plug, covered up to maintenance schedule
  - 2 Ignition Module

## MAINTENANCE STATEMENT

The owner is responsible for the performance of all required maintenance, as defined in the operator's manual.



**WARNING!** Cutting, especially when DRY cutting, generates dust that comes from the material being cut, which frequently contains silica. Silica is a basic component of sand, quartz, brick clay, granite and numerous other minerals and rocks. Exposure to excessive amount of such dust can cause:

Respiratory disease (affecting your ability to breath), including chronic bronchitis, silicosis and pulmonary fibrosis from exposure to silica. These diseases may be fatal;

Skin irritation and rash.

Cancer according to NTP\* and IARC\*  
\*/ National Toxicology Program, International Agency for Resaearch on Cancer

Take precautionary steps:

Avoid inhalation of and skin contact with dust, mist and fumes.

Wear and ensure that all bystanders wear appropriate respiratory protection such as dust masks designed to filter out microscopic particles. (See OSHA 29 CFR Part 1910.1200)

Wet cut when feasible, to minimize dust.

**Original instructions**

**1153350-95**



**2009-12-29**