



Husqvarna®



## Operator's manual **Soff-Cut 4200**

Please read the operator's manual carefully and make sure you understand the instructions before using the machine.

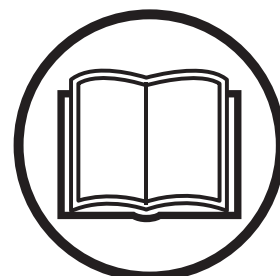

**GB**

# CONTENTS

Content	Page
Table of contents .....	2
Unpacking .....	2
Transporting .....	2
Sound Data .....	2
Introduction, personal safety .....	3
Registration of the product .....	4
General safety message .....	4
Safety warnings .....	5
Excel series blades .....	6
Blade and skid plate installation .....	6
What is what? .....	7
Operating instructions .....	8-9
Fuel and fuel safety warnings .....	10
Recommended fuels .....	10
Recommended oils .....	10
Engine and transmission maintenance .....	11
Other maintenance .....	12
Sawing contraction joints .....	13
Troubleshooting .....	14
Technical specifications .....	15
Conformity certificates .....	15

# UNPACKING

Your **4200** saw has been shipped from the factory thoroughly inspected. Only minimal assembly is required to start using the saw. Remove the saw from the container using proper lifting techniques. Discard or recycle the packing material per your regional laws. In your container will be the **4200** saw, diamond blade, skid plate, blade shaft wrench, spark plug wrench, an owner's manual, an engine owner's manual, a part list, a warranty card, a joint protector sample pack and a ramp for unloading the saw. Connect the battery cables and turn the key switch to the "ON" or "1" position on the instrument panel. Press the rocker switch on the instrument panel to raise the saw. Place the unloading ramp at the edge of the container and roll the saw out of the container. Lower the saw and turn the key switch to the "OFF" or "0" position.

# TRANSPORTING

The **4200** saw weights approximately 496 pounds (225 kilograms) when ready to use . Use safe lifting practices when handling the saw. Always remove the diamond blade when transporting the saw. Always transport the saw with a skid plate installed. Retract the guide arm. The saw can be lifted from the side and front handles or using the optional lifting kit and sling. Always store and transport the saw in a completely lowered position and secured from moving.

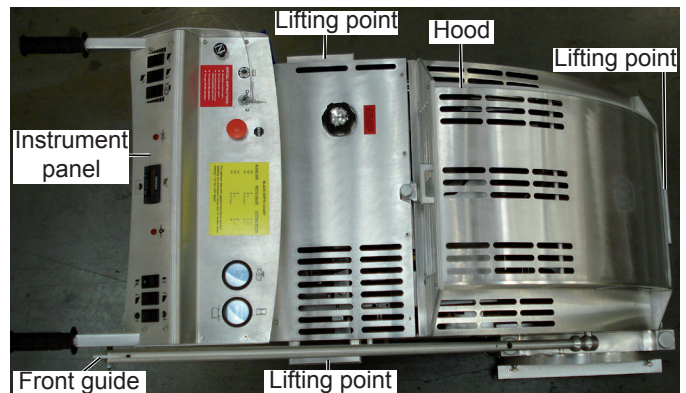

## CAUTION

Only use the side and front lifting handles when lifting the **4200**.

---

# INTRODUCTION

---

## Common sense:

The focus of this manual is HOW to operate and service the equipment safely.

It is not possible to cover every conceivable situation you can face when using this equipment. Therefore use this product only in a manner described in this manual. Operation or handling the machine in any other manner can lead to serious injury or death.

If a situation is not described in this manual it should be considered dangerous - and not be done.

If you are unfamiliar with this product make sure that you carefully understand how it functions and practice all operations and handling before putting the machine to use. Familiarize yourself in the presence of an experienced operator. Avoid all situations that are beyond your capability.

If you still feel uncertain about the operating procedures after reading these instructions DO NOT operate the machine until you have consulted an experienced operator.

If you have further questions you can contact the closest Husqvarna Construction Products location by writing or calling, see information below. You can also find the closest location by searching the internet at; **www.husqvarnacp.com** . Husqvarna Construction Products will willingly be of service and provide you with advice as well as help you to use your product both efficiently and safely.

Additional manuals are available at NO CHARGE and can also be obtained on the internet site.

Husqvarna Construction Products  
265 Radio Road  
Corona, California 92879  
USA

**Toll Free no:** 800 776 3328 (USA & Canada)  
**Phone no:** 951 272 2330  
**Telefax no:** 951 272 2338

Internet Site: **www.husqvarnacp.com**

---

## PERSONAL SAFETY EQUIPMENT

---

When working and operating the saw the following approved personal safety items should be used:



Head  
Protection



Hearing  
Protection



Eye  
Protection



Safety  
Shoes



Protective  
Gloves

# REGISTER THE PRODUCT

Please register your new **4200** with Husqvarna Construction Products by mailing in the registration card that came with the machine or you can register on the internet site [www.husqvarnawarranty.com](http://www.husqvarnawarranty.com)

Registration will allow us to contact in case of any critical updates or recalls on this machine. Warranty registration has also been found to be helpful in tracing stolen equipment.

Record the following information for your records:

PURCHASE DATE: \_\_\_\_\_

MODEL No: \_\_\_\_\_

SERIAL No: \_\_\_\_\_

ENGINE MODEL: \_\_\_\_\_ ENGINE TYPE: \_\_\_\_\_ ENGINE CODE: \_\_\_\_\_

*The 4200 model and serial number as well as the engine model number, engine type and code are critical in order to obtain the correct service parts.*

## SAFETY DEFINITIONS

In this manual a Safety Alert Symbol  followed by the signal words WARNING and CAUTION are used to identify safety information about hazards which can result in death, serious injury and/or property damage.

These signal words mean:

 **WARNING** indicates a hazard which, if not avoided, **could result in death or serious injury.**

 **CAUTION** indicates a hazard which, if not avoided, **might result in minor or moderate injury.**



**NOTICE** indicates a message not related to personal injury.

## SAFETY HAZARDS

### **WARNING**

#### DO NOT MODIFY THE PRODUCT

**Under no circumstances may the design of the machine be modified without the permission of the manufacturer. Always use genuine accessories. Unauthorized modifications and/or accessories can result in serious personal injury or the death of the operator or others. Your warranty may not cover damage or liability caused by the use of unauthorized accessories or replacement parts.**

 <b>WARNING</b>	 <b>WARNING</b>	 <b>CAUTION</b>
<b>ASPHYXIATION HAZARD</b> Running an engine in a confined or badly ventilated area can result in injury or death due to asphyxiation or carbon monoxide poisoning.	<b>CALIFORNIA PROP 65</b> Use of this product can expose you to materials known to the State of California to cause cancer and/or birth defects or other reproductive harm.	<b>HEARING HAZARD</b> During the normal use of this machine, operator may be exposed to a noise level equal to or higher than 85 dB(A). Use hearing protection.

---

# SAFETY WARNINGS

---



## WARNING

Failure to comply with the following warnings could result in serious bodily injury or death!

### PERSONAL SAFETY

- Read and understand instructions before operating saw.
- Always wear safety approved hearing, eye, head and respiratory protection.
- Wear boots with non-slip soles to provide proper footing. Steel-toed safety boots are recommended.
- Wear rubber work gloves to avoid contact with wet concrete which can cause serious skin irritation.
- Know how to stop the saw quickly in case of emergency.
- Keep all parts of your body away from blade and other moving parts. Do not wear loose clothing or jewelry which can be caught in moving parts. Wear protective hair covering to contain long hair.
- Use caution when loading and unloading saw.
- Stay alert. Maintain awareness of saw operation. Use common sense. Do not operate saw when tired or after consumption of any substance that would impair physical function or rational judgment.
- Do not over reach. Keep proper footing and balance.

---

### WORK AREA SAFETY

- Never operate the saw in any application or job where you are not trained or supervised.
- Keep visitors, children and animals out of the work area.
- Observe all safety regulations for the safe handling of fuel. Gasoline is extremely flammable and its vapors can explode if ignited. Do not refuel indoors or in poorly ventilated areas. Handle fuel in safety containers. Shut off the engine and allow it to cool before refueling. Wipe the saw dry if fuel is spilled on it. Always move away from the fueling area before starting the engine. Do not smoke while refueling.
- Do not operate the saw while smoking or near an open flame.
- Do not operate the saw in areas of combustible material or fumes. Sparks may occur from the saw that could cause a fire or explosion.
- Operate only in well ventilated areas. Engine exhaust contain carbon monoxide which can cause loss of consciousness and possible death.
- The muffler and engine become very hot during operation. Keep all body parts and foreign material away from the engine while running.
- Avoid dangerous environments. Do not expose saw to rain. Keep work area well lit and clean.

### SAW SAFETY

- Do not leave saw unattended while the engine is running.
- Do not alter the saw. Any alteration or modification is misuse and may result in a dangerous condition.
- All safety guards must be in place before starting the engine.
- Only operate the saw from behind the machine with both hands on the handle.
- Do not use damaged equipment, blades, guards or personal protection equipment. Do not disable safety equipment or kill switches.
- Do not operate the saw if there is a fuel leak.
- Use extreme caution when maneuvering the saw on ramps or loading and unloading from trucks or trailers.
- Use only Husqvarna Construction Products replacement parts. Use of unauthorized parts may create a danger.
- Do not use the saw as vehicle for transporting personnel or equipment.
- Remove the ignition cable from the spark plug before performing saw maintenance or changing blades to prevent accidental engine starting.
- Remove all wrenches from the saw before starting.
- Never stand on the saw.
- When the saw is not in use or transporting, remove the blade and lower the saw completely. Properly secure the saw to prevent accidental movement.

---

### BLADE SAFETY

- Examine cutting blades before each use. Do not use any blades that has cracks, nicks, or flaws. Tri-arbor hole should be undamaged. Use only dry cut, steel centered, tri-arbor diamond blades made for cutting green concrete.
- Husqvarna Excel Series diamond blades are designed to only cut green concrete. Cutting any other material may result in blade failure or a dangerous condition.
- Inspect blade flanges for damage, excessive wear and cleanliness before mounting the blade. The blade should fit snugly on clean, undamaged, tri-arbor shaft.
- Use only Husqvarna Excel Series blades or blades marked with a maximum operating speed greater than 3500 rpm.
- Never operate the saw without the blade block assembly securely in place including blade cover, lexan shields and skid plate installed in working order. A damaged blade block assembly must be replaced to protect the operator.
- Make sure the blade does not make contact with the ground or any other surface when maneuvering the saw.
- Avoid getting in direct line with the blade or contacting the blade while it is rotating.

# EXCEL SERIES BLADES

The Excel Series of diamond blades have been designed specifically for the Soff-Cut Ultra Early Entry dry cutting system of green concrete. These specialty blades are designed to increase speed and life while cutting a wide range of aggregates. Choose the correct specification of diamond blade for your area as follows:

Purple Excel Series 1000	XL14-1000	Ultra hard aggregate and non abrasive sand
Green Excel Series 2000	XL14-2000	Hard to ultra hard aggregate and non abrasive sand
Red Excel Series 3000	XL14-3000	Hard aggregate, medium abrasive sand
Orange Excel Series 4000	XL14-4000	Medium hard aggregate, medium abrasive sand
Yellow Excel Series 5000	XL14-5000	Medium hard to soft aggregate, abrasive sand
Black Excel Series 6000	XL14-6000	Soft aggregate, highly abrasive sand

## BLADE AND SKID PLATE INSTALLATION

### Step 1

Turn the key switch (located on the instrument panel) to the "ON" or "1" position. Press the blade depth rocker switch in the instrument panel to raise the saw to its full height. Turn the key to the "OFF" or "0" position.

### Step 2

Remove the blade block cover (A) by turning the two locking knobs counter-clockwise. Insert the blade wrench supplied with the saw on the blade shaft bolt (B) on the end of the blade shaft in the blade block (C). Rotate the blade shaft counter-clockwise with the wrench on the blade shaft bolt (C) while pushing in on the blade shaft locking pin (D) located on the front of the saw frame. The locking pin will drop in the blade shaft and prevent the shaft from rotating.

### Step 3

Remove the blade shaft bolt by continuing to turn the bolt counter-clockwise. Remove the outer arbor washer or flange (E).

### Step 4

Match the blade tri-arbor to the blade shaft arbor (F) and install the blade firmly against the rear flange (F). Insure the blade is installed on the tri-arbor correctly. Match the female tri-arbor of the outer washer or flange with the blade shaft and install the blade shaft bolt turning clockwise while holding the locking pin in. Be sure the outer flange is fully seated and firmly holding the diamond blade in position.

### Step 5

Install a new skid plate (G) by hooking the front on the front blade block shaft pin. Connect the rear blade block shaft and the rear of the skid plate by installing the locking pin.

### Step 6

Install the blade cover by turning the two knobs and tighten until fully seated against the blade block. Lift the front and rear of the skid plate to insure the blade slides through the skid plate freely.

### Step 7

Insure the lexan shields (H & I) move freely up and down. When replacing a worn blade, thoroughly clean the concrete from blade block and blade cover before installing the new blade. Discard the old skid plate and replace it with a new skid plate.



### WARNING

Inspect the blade (K) for any damage. Do not use any blade that has cracks, nicks, flaws or a damaged arbor. Make sure the blade is marked with a maximum operating speed greater than 3500 rpm.

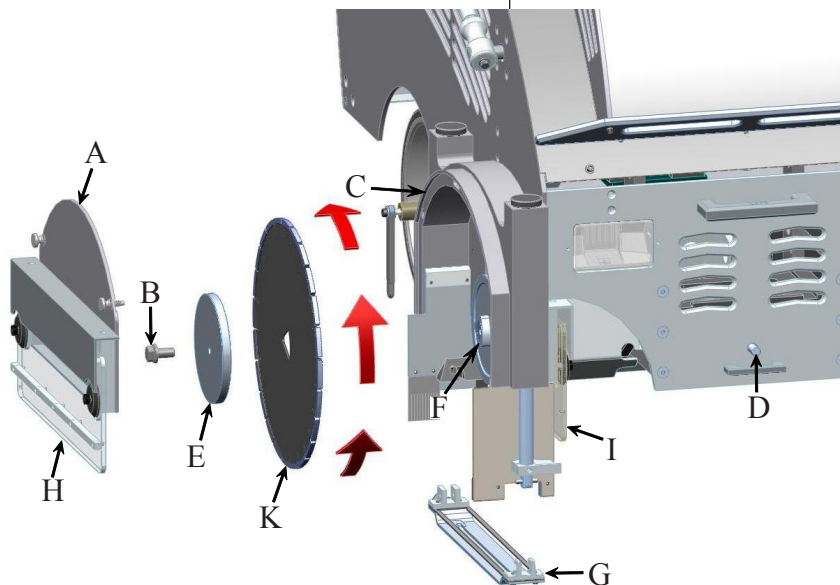

# WHAT IS WHAT

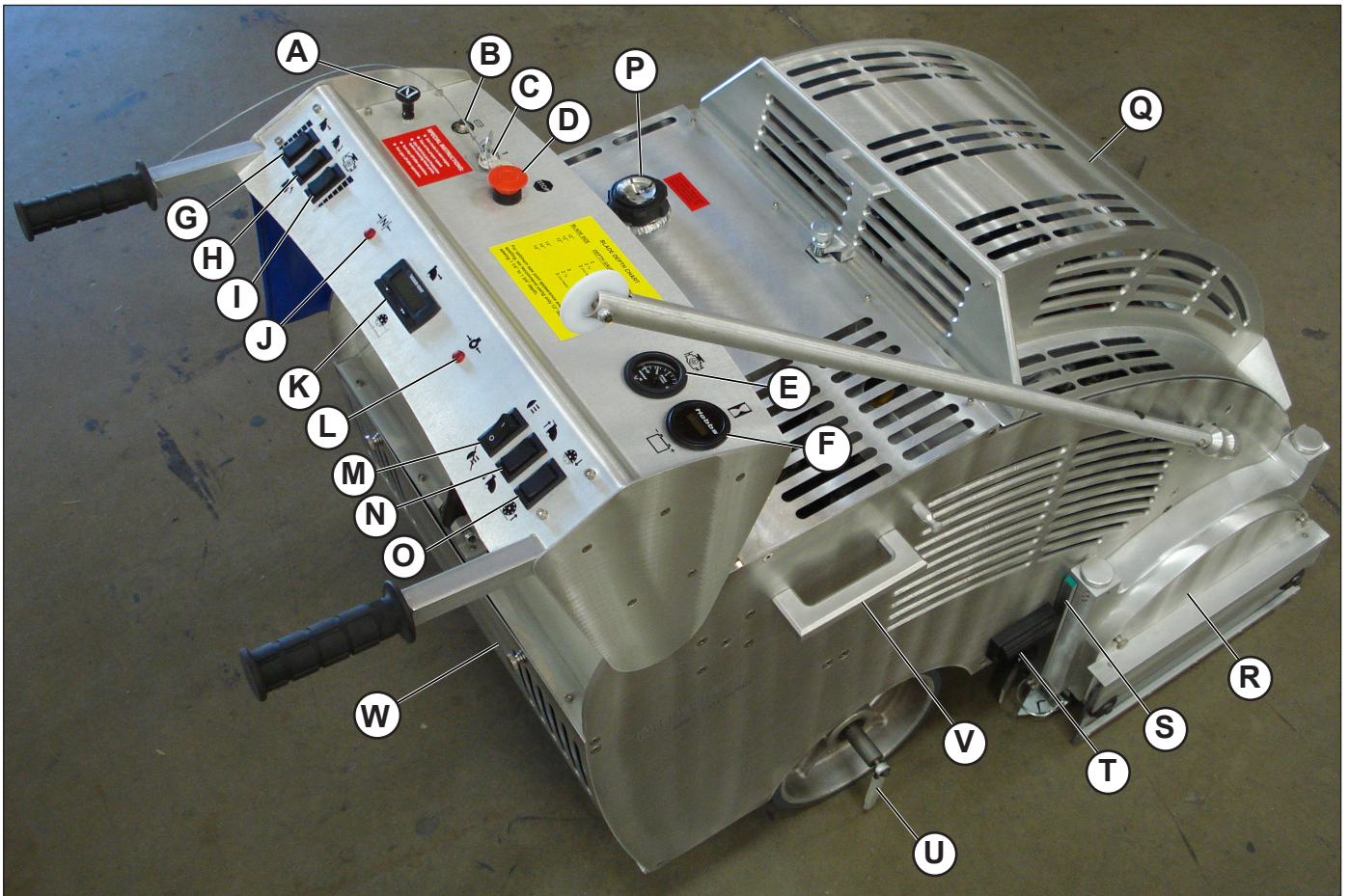

## What is what?

- A. Choke
- B. Circuit breaker
- C. Engine on/off switch
- D. Emergency stop switch
- E. Tachometer
- F. Hour meter/Volt meter
- G. Saw forward speed switch
- H. Guide switch
- I. Engine speed switch
- J. Transmission neutral light
- K. Digital display
- L. Engine oil alert light
- M. Light switch
- N. Handle bar height switch
- O. Blade depth switch
- P. Fuel cap/gauge
- Q. Hood
- R. Blade block
- S. Cut depth pointer
- T. Side light
- U. Rear guide
- V. Lifting handle
- W. Rear access panel
- X. Battery
- Y. Oil dipstick
- Z. Oil fill cap

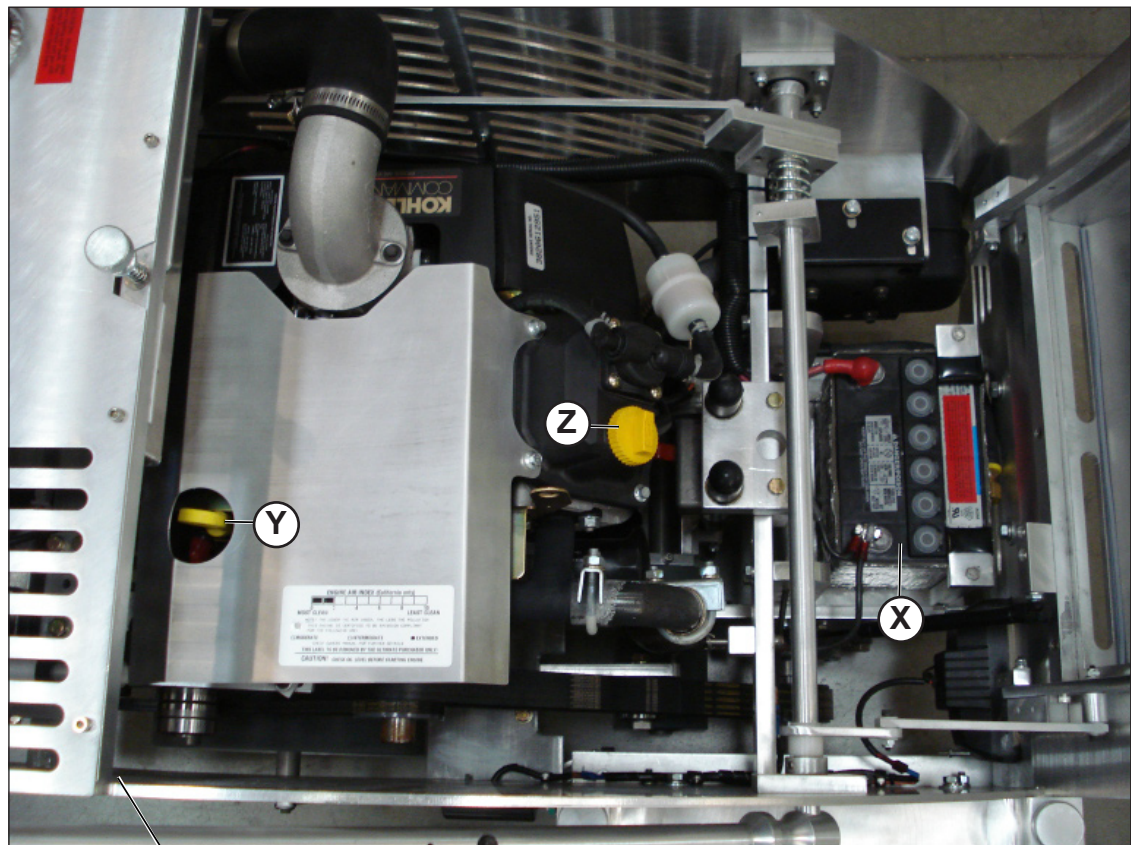

Model number and serial number

# OPERATING INSTRUCTIONS

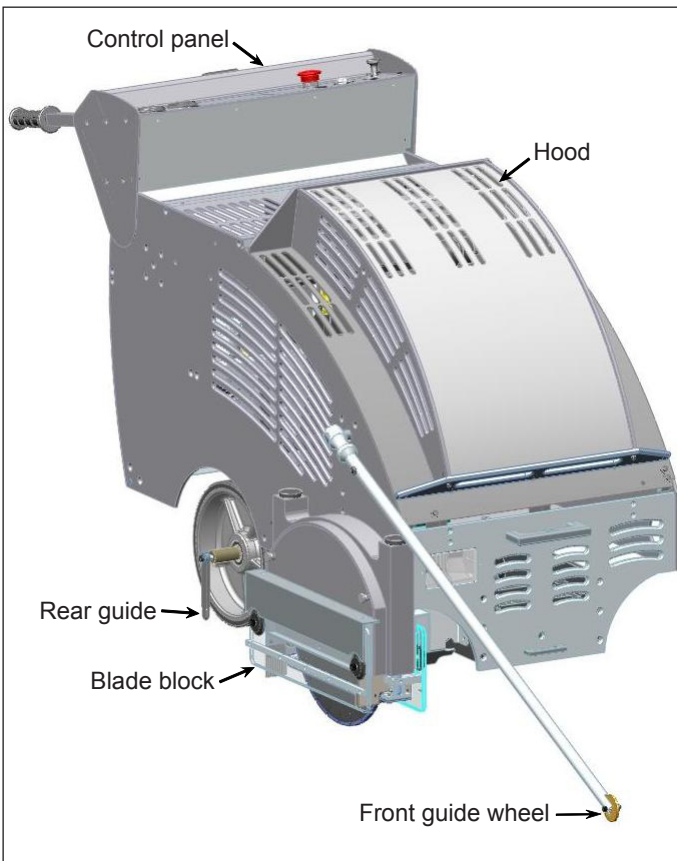

Experience is very important when running the **4200** saw. A skilled worker is highly recommended. Always do an inspection of the saw before starting the engine. Check the fuel (P) and oil level (Y) per the enclosed engine manual. SAE 10W/30 oil and unleaded gasoline with an 87 or higher octane should be used. The hydrostatic transmission use Mobil DTE 26 hydraulic oil or equivalent (20W with viscosity of 68). **Observe all safety regulations for the safe handling of fuel. Always check the engine oil with the saw turned off, completely lowered and the engine level!** Check that all controls are in good working order. Check for loose bolts or nuts. Check for fuel or oil leaks. Insure all guards are secure, undamaged and properly installed.

**! WARNING**  
Do not operate saw if there is a fuel leak!

**! WARNING**  
Do not operate the saw unless all guards, safety equipment and the engine kill switch are in place and operational!

Check the air filter and clean or replace if necessary. Check for proper specification of blade and that the skid plate operates properly. Check that the blade and skid plate are in good condition. Make sure the work site is clean, well lit and hazard free.

To start the engine, turn the key switch (C) to the "ON" or "1" position to activate the rocker switches. Raise the saw by pushing the blade rocker switch (O) on the instrument panel to the full up position. Push the saw forward speed rocker switch (G) into neutral indicated by the red light (J) on the instrument panel. Make sure the red emergency stop button (D) is in the "up" position. **The saw will not start unless the emergency stop is "up".**

Close the engine choke (A) by pulling up on the knob. The closed choke position enriches the fuel mixture for starting a cold engine. The open choke position provides the correct fuel mixture for operation after the engine starts and for restarting a warm engine. Start the engine by turning the key switch (C) to "START" or "2" position and release once the engine starts. Slowly open the choke (A) by pushing down on the knob. Allow the engine to warm for a few minutes.

**NOTE:**  
The hour meter (F) runs when the key is "ON" even if the motor is not running.

**! WARNING**  
**ASPHYXIATION HAZARD**  
Running an engine in a confined or badly ventilated area can result in injury or death due to asphyxiation or carbon monoxide poisoning.

Open the engine throttle lever to full open position for maximum engine speed by pushing the engine speed rocker switch (I). Lower the front guide to the full down position by depressing the guide arm rocker switch (H).

Line up the saw with the cut line using the front guide wheel, the rear guide (U), and the triangle pointer on the back of the blade block. Press the blade rocker switch (O) to lower the blade in the concrete slowly to the desired depth (S) shown on the back of the blade block.

Move the saw forward by tapping the forward speed rocker switch (G) until the desired cutting speed is reached. Keep the front guide wheel on the cut line to insure straight cuts. Make small adjustments by applying side pressure on the handle to keep the saw straight.

Move the saw at about half speed for the first 200 feet to allow the blade to develop good diamond exposure or open up and promote full blade life. Increase the forward speed of the saw until the blade and the engine are working at maximum efficiency.



cont...

Increase the forward speed if the saw is pulling left. Decrease the forward speed if the saw is pulling right. **Do not force the saw.** When approaching a wall, raise the front guide and use the triangle guide at the back of the blade block to cut the last few feet.

**Do not hit the blade block assembly against any object.** Damage may result. Slow the forward speed by pressing the forward speed rocker switch (G) until the saw stops. Press the blade rocker switch (O) to raise the saw out of the cut to full "UP" position.

The self propel function of the saw will not operate with the unit in a raised position. Press the engine speed rocker switch (I) to lower the engine speed. Turn the engine kill switch to the "OFF" or "0" position. Lower the saw to the down position.



### WARNING

**Do not leave the saw unattended while the engine is running! Always secure the saw from movement while unattended.**

#### NOTE:

**Do not walk on the joints or transport equipment across the joints until the concrete fully hardens.**

Periodically, clean any excess concrete from inside the blade block, scrapers and blade block cover. Always clean the blade block assembly thoroughly before storing the saw.



### WARNING

**Before each use, carefully inspect the 4200 for any damage to any of its parts and components. Pay careful attention to any leakage of gasoline or oil. Under no circumstance should the 4200 or any of its attachments be operated if you find damage or are suspicious that something appears to be damaged.**

#### DIGITAL DISPLAY (K)

The digital display in the center of the instrument panel indicates the travel speed of the saw and the total distance cut by the saw. Push the left arrow button until the display shows "R" on the left of the display. The unit is set to show the travel speed of the saw in feet/minute in the US and meters/minute outside the US. Pressing the left arrow button again changes the display to the total distance cut by the saw. The R button on the right resets the cut distance to zero.

#### HOURLY METER/VOLT METER GAUGE (F)

The hour meter and volt meter are incorporated in the same gauge. With the engine running, the volt meter is operating. The gauge reads the total saw hours when the engine is not running.

#### TACHOMETER GAUGE (E)

The tachometer gauge provides the engine speed in revolutions per minute (rpm).

#### OIL ALERT LIGHT (L)

The oil alert light indicates a drop in engine oil pressure. If the light illuminates, immediately turn the engine off. Do not use the engine if the oil alert is lit or engine damage may occur.

## FUEL HANDLING



### WARNING

Taking the following precautions will lessen the risk of injury and property damage:

- Use extreme care in handling gasoline. It is extremely flammable and the vapors are explosive.
- Extinguish all cigarettes, cigars, pipes, and other sources of ignition.
- Use only approved gasoline containers.
- Never remove gas cap or add fuel with the engine running. Allow engine to cool a minimum of 3 minutes before refueling.
- Never fuel the machine indoors.
- Never store the machine or fuel container where there is an open flame, spark, or pilot light such as on a water heater or other appliances.
- Never fill containers inside a vehicle or on a truck or trailer bed with a plastic liner. Always place containers on the ground away from your vehicle when filling.
- Remove the **4200** from the truck or trailer and refuel it on the ground. If this is not possible, then refuel the equipment with a portable container, rather than from a gasoline dispenser nozzle.
- Keep the nozzle in contact with the rim of the fuel tank or container opening at all times until fueling is complete. Do not use a nozzle lock-open device.
- If fuel is spilled on clothing, change clothing immediately.
- Never overfill fuel tank. Always wipe off any spilled fuel or oil. Replace fuel cap and tighten

## PROPER FUEL

The Kohler engine is certified to operate on automotive unleaded gasoline with a pump octane rating (M+R) of 87 or higher. Fuel tank capacity is 3.0 gallon (11 liter).

Refuel in a well-ventilated area with the engine **stopped**.

You may use regular unleaded gasoline containing no more than 10% ethanol (E10). Do not use gasoline containing methanol.

Use of fuels with an ethanol content of more than 10% (E10) may cause starting and/or performance problems. It may also damage metal, rubber, and plastic parts of the fuel system, as well as posing a fire hazard.

Do not use fuel that is older than 30 days. Old fuel can cause running problems as well as fuel system damage.

**The engine will not operate on gasoline marketed as E-85 (85% ethanol)**

## OIL HANDLING

### NOTICE

Used oil is a hazardous waste product. Dispose of used oil properly. Do not discard with household waste. Check with your local authorities, service center, or dealer for safe disposal/recycling facility.

## ENGINE OIL

### Oil Recommendation

The engine holds approximately 2 quart (1.9 liter) when changing oil.

- Use a 4-stroke automotive detergent oil of API service class SE or higher grade.
- Do not use special additives.
- Choose a viscosity according to the table below.

Please read the enclosed Kohler Operator's Manual for complete oil information.

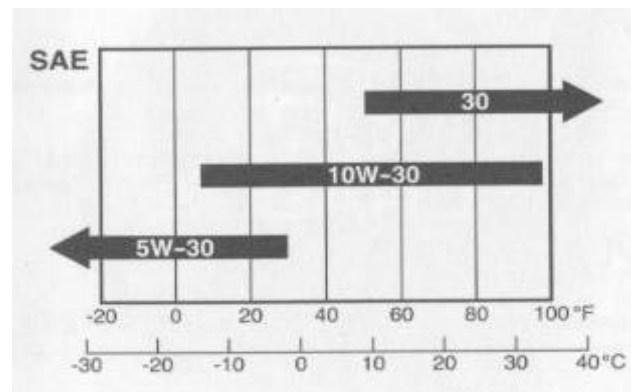

## HYDROSTATIC TRANS OIL

**Mobil DTE 26** hydraulic oil or equivalent (20W with viscosity of 68)

# ENGINE AND TRANSMISSION MAINTENANCE

## Engine Oil

### Checking, Adding and Changing Oil

Check the engine oil level (A) daily with saw fully lowered and the engine level. See the enclosed Kohler manual for more details.

Use SAE 10W-30 viscosity detergent automotive type with API service class SE or higher grade oil.

**Note:** Engine holds approximately 2 quart (1.9 liter) when changing oil and oil filter.

### Changing the Oil

Change oil after the first 5 to 8 hours of use. Thereafter every 50 hours.

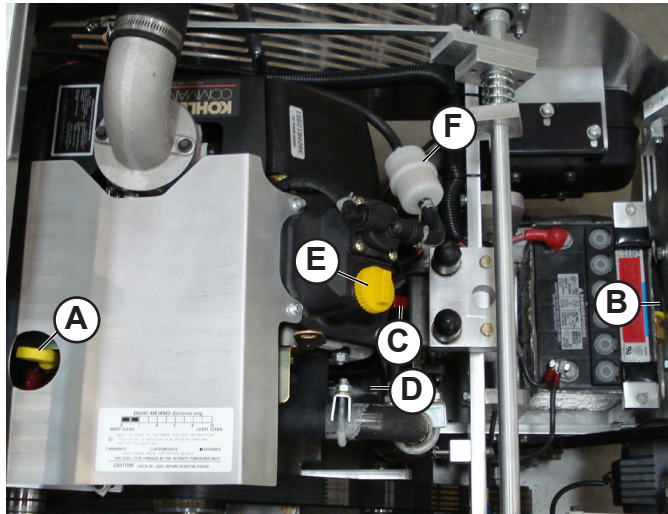

The oil drain hose (B) is located at the front of the saw by the battery.

1. With the engine OFF but still warm, pull the hose (B) down, remove the brass cap and place the end of the hose in a pan.
2. On the bottom and front of the engine is the oil drain valve (C). Turn the handle until it is in line with hose which opens the flow of oil.
3. Before installing new filter, lightly oil filter gasket with fresh, clean oil.
4. Screw filter (D) on by hand until gasket contacts oil filter adapter. Tighten 1/2 to 3/4 turn more.
5. Close the oil drain valve.
4. Replace the brass cap on the oil drain hose.
5. Fill the engine at the oil fill cap (E) to the "F" mark on the dipstick (A) with 2 quarts (1.9 liters) of oil.

The engine is equipped with an oil pressure switch that illuminates a light on the instrument panel if the oil pressure is to low. **Do not run the engine if the oil pressure light illuminates on the instrument panel or engine damage could occur.**

## NOTICE

**Used oil is a hazardous waste product. Dispose of used oil properly. Do not discard with household waste. Check with your local authorities, service center, or dealer for safe disposal/recycling facility.**

### Fuel filter

Inspect the fuel filter (F) every 50 hours. Replace the fuel filter annually.

### Air filter

The air cleaner assembly (G) is a canister style that can be accessed from the rear access panel of the saw. The outer air cleaner element should be replaced every 50 hours. Refer to the supplied engine manual and the "Heavy-Duty Air Cleaner" for additional information.

### ADDITIONAL ENGINE INFORMATION

Please see the Kohler Operator's Manual for additional information about servicing the engine.

The manual also has specific information about specifications, tune-up parts, engine warranty, emission compliance, etc.

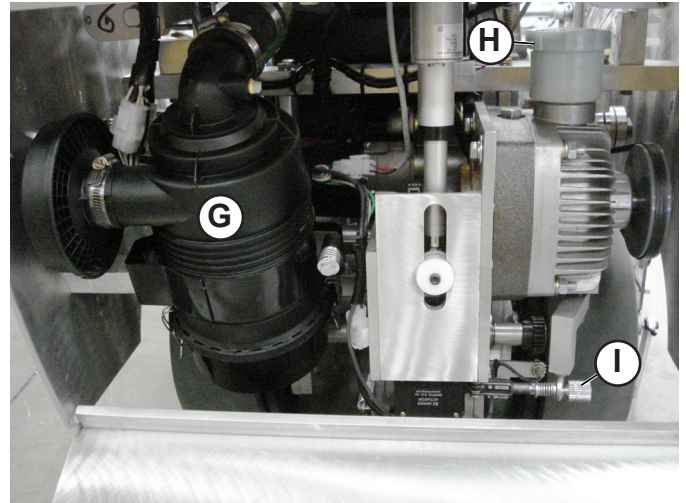

### Transmission oil

Check the transmission oil level daily. The transmission is accessible from the rear access panel of the saw. The oil reservoir (H) located on the top of the transmission has an oil level line 1/8" (3 mm) from the bottom of the reservoir to indicate the proper fluid level when cold. Use hydraulic oil 20W with viscosity of 68 Mobil DTE 26 or equivalent.

### Transmission neutral

With the saw transmission neutral light illuminated, the saw should fully stop and not creep or move. To adjust the transmission neutral position, open the rear access panel. In the lower right hand side, turn the transmission adjustment knob (I) until the saw stops completely with the transmission neutral light illuminated.

# OTHER MAINTENANCE

## Battery

The battery is maintenance free. If the battery ever requires charging, use only a voltage regulated taper current charger designed specifically for sealed lead acid gel cell batteries rated at 2 amps or less (part # 505583501). A standard automotive, or any other type, battery charger not designed specifically for sealed gel batteries will cause permanent damage to the installed battery and void any warranty. Do not leave the ignition key in the "ON" position as this will drain the battery.



### WARNING

- Connecting and disconnecting a battery can cause sparks and short circuits. Do not short battery terminals by allowing a wrench or any other object to contact both terminals at the same time.
- A spark or flame can cause a lead acid battery to explode.
- Before connecting a battery, remove metal bracelets, wristwatch bands, rings, etc. Use gloves and protective glasses or face shield when working with a battery.



Eye Protection



Protective Gloves



Explosion Danger

## Guards

Check all guards for damage and proper function daily especially the blade block. Blade block and cover should be secure to the saw and not damaged. Lexan side covers on the blade block should move freely up and down.

## Diamond blade

Inspect diamond blades daily for damage, cracks, secure fit to the arbor, loss of segments, warping or overheating. **If any blade shows any of these problems, discard the blade and never use.**

## Skid plate

Inspect the skid plate daily for damage, excessive wear in the blade slot, burrs on the concrete surface side, twisting and free movement up and down when installed on the blade block. Replace the skid plate with each new diamond blade. Never reuse the skid plates or spalling and raveling may result.

## Saw controls

Inspect all controls for proper function daily. **Check all the interlocks for operation especially the red emergency stop button and engine on/off switch for proper operation.**

## Belts

Inspect the blade drive belt and transmission belt for cracks or signs of wear. The belt tension is controlled by belt tensioners and does not require adjustment. Inspect the belt tensioners for free movement up and down. Insure the belt tensioner bearings roll freely.

## Blade shaft bearings

Lubricate the blade shaft bearings with 3 pumps of Lithium 12 based grease every 50 hours.

## Cleaning

Clean the blade block of any excess concrete build up after each use. Keep the handle bars and controls clean and dry. Immediately clean any spilled fuel from the saw. Keep all openings and slot on the saw clean open so air flows freely through the engine compartment to insure proper cooling.

## MAINTENANCE SCHEDULE

Check guarding, diamond blade, skid plate, lexan covers, controls and oil levels.	Daily
Clean blade block assembly and saw.	Daily
Replace air cleaner.	Every 50 hours
Replace engine oil.	Every 50 hours
Grease blade shaft bearings.	Every 50 hours
Check blade drive belt, the transmission drive belt and belt tensioner.	Every 50 hours
Replace the fuel filter.	Annually



### WARNING

**Do not modify the saw! Use only Husqvarna Construction Products replacement parts. Use of unauthorized parts may create a danger or damage the engine.**

# SAWING CONTRACTION JOINTS

As concrete hydrates or cures and begins to set, it develops internal stresses which may cause random cracks. Random cracks cast doubt on the quality and workmanship of the concrete. Contraction joints are cut in concrete to relieve these stresses before they seek their own relief in the form of random crack. The Soff-Cut Ultra Early Entry system controls random cracking through the early timing of a saw cut at predetermined locations to create weakened planes in the concrete that subsequently crack at the bottom of the cut to relieve stress. Husqvarna sawed contraction joints should be a minimum of 1/8th the concrete depth and a minimum of 1" (25mm) deep. Contraction joints should be sawn as soon as the concrete will support the weight of the saw and the operator without marking or damaging the concrete. There are many possibilities for joint layout. Joint layout should be provided, the saw contractor should submit a detailed joint layout for approval prior to cutting. Several factors affect joint spacing including:

- Concrete thickness
- Type, amount and location of reinforcement
- Shrinkage potential of concrete-cement (type, quantity), aggregate (size, quantity, quality), water to cement ratio, admixtures, concrete temperature
- Base friction
- Slab restraints
- Layout of foundations, racks, pits, equipment pad, trenches, etc.
- Environmental factors - temperature, wind, humidity
- Methods and quality of concrete curing.

Generally, contraction joint patterns should divide slabs into approximate square panels per the recommended spacing shown.

<b>RECOMMENDED CONTRACTION JOINT SPACING</b>	
<b><u>Concrete thickness, in. (mm)</u></b>	<b><u>Maximum spacing, ft. (m)</u></b>
3.5 (90)	8 (2.4)
4, 4.5 (100, 114)	10 (3.0)
5, 5.5 (125, 140)	12 (3.6)
6 (150) or greater	15 (4.5)

At all intersecting cross cuts, install Husqvarna joint protectors at each joint to prevent joint damage. Install an additional joint protector where the right wheel will cross the joint to prevent concrete damage.

---

# TROUBLESHOOTING

---

## SAW IS SPALLING AND RAVELLING CUT

- Check to see if the diamond blade is worn out, glazed, warped or damaged.
- Insure skid plate moves freely up and down the entire shaft length without contacting the diamond blade.
- Check skid plate for excessive wear or gap around the diamond blade.
- Check skid plate for tension or loose mounts. Skid plates are preset at the factory.
- Check bottom of skid plate for metal burrs or irregularities.
- Insure skid plate is not twisted or bent.
- Check lexan covers for free movement up and down.
- Insure there is spring down pressure at each end of the skid plate.
- Do not twist or move the saw sideways while cutting.
- Check that the engine is running properly and at full throttle.
- Check belt and belt idler for proper tension.
- Insure the diamond blade is properly mounted and secured with clean flanges.
- Insure that the diamond blade is the correct specification for your area.
- Insure the slab is in clean with no debris that could raise the skid plate or saw while cutting.
- Use Husqvarna joint protectors at all cut intersections.
- Clean excess concrete debris from the blade block assembly.
- Check that the scrapers in the blade block are not bent or binding.
- Insure that the blade block shafts are not bent or damaged.
- Check that the front diverter in the blade block is not bent and the diverter legs are not contacting the concrete.

---

## ENGINE RUNS ROUGH, BACK FIRES OR CAN NOT REACH FULL SPEED

- Check if there is fuel in the tank and it is the correct fuel. Make sure there is no water in the fuel.
- Check that the spark plugs are clean and properly gapped.
- Check that choke is in the "off" position after engine is warm.
- Check that air filter is not dirty or plugged.
- Check that the throttle lever is properly set.

## ENGINE WILL NOT START

- Check that the red emergency stop button is pulled up.
- Check if there is fuel in the tank and it is the correct fuel. Make sure there is no water in the fuel.
- Check that the spark plug wires are connected to the spark plugs.
- Engine is flooded. Adjust the choke per the engine owner's manual.
- Check that the air filter is not dirty or plugged.
- Check the choke is in the "on" position for cold starts. Adjust the choke per the engine owner's manual.
- Check that the blade shaft rotates freely and no concrete has built up in the blade block.

---

## SAW PULLS TO ONE SIDE WHILE SAWING

- Check front and rear guide is properly aligned with the center of the diamond blade.
- Check to see if diamond blade is worn out, glazed, warped or damaged.
- Do not twist or move the saw sideways while cutting. Make gradual changes in pressure on the handlebar to control the saw in the cut.
- Insure that all wheels rolls freely and smoothly.
- Do not force the saw. Allow the diamond blade to cut at its own rate of speed.
- Check the skid plate for damage or burrs.
- Insure both driver gears are contacting the rear wheel gears, all gears and rear wheels are clean and not damaged.

# TECHNICAL SPECIFICATIONS

Engine	
Model	Kohler Command Pro CH22S
Engine oil volume, quarts/liters	2/1.9
Gasoline tank volume, gal/liters	33.0/11
Type	Air cooled, 4-cycle, twin cylinder, hydraulic overhead valves, gasoline engine
Air filter	Tri phase remote mount canister style
Oil system	Full pressure lubrication with spin-on oil filter
Muffler	Low noise, side exhaust
Emissions	Complies with EPA Phase 2 and CARB Tier II USA regulations
Cooling	Air cooled
Cylinder	Aluminum with cast iron liner
Controls	Instrument panel mounted manual choke, electric switch operated throttle, keyed on/off switch

Weight and Dimensions	
Weight – dry, lbs/kg	472/214
Weight with gasoline and oil full, lbs/kg	496/225
Length (handle folded in), inch/mm	59/1499
Width, inch/mm	30/762
Height, inch/mm	38/965

Blade	
Material cut	Green concrete only
Blade type	13.5" (343 mm) or 12.0" (305 mm) dry cut with tri-arbor
Blade rotation	Counter clockwise, upcutting

Blade shaft speed, rpm	3500
Cutting depth	3 inch maximum (76 mm) depending on blade size and amount of blade wear
Cutting distance from wall, inch/mm	3 1/2 / 89

Average cutting rate - Estimate only. Speed will vary with job conditions and concrete mixes.		
	3 inch (76 mm) depth	2 inch (51 mm) depth
Soft aggregates, ft/min / m/min	16/4.9	26/7.9
Medium aggregates, ft/min / m/min	12/3.7	18/5.5
Hard aggregates, ft/min / m/min	8/2.5	10/3.0

Blades are available in 13.5 inch (343 mm) and 12 inch (305 mm) diameters and in 0.100 inch (2.5 mm), 0.250 inch (6.4 mm), 0.380 inch (9.7 mm), and 0.500 inch (12.7 mm) widths.

Noise emissions (see note 1)	
Sound power level, measured dB(A)	105
Sound power level, guaranteed dB(A)	106
Sound levels (see note 2)	
Sound pressure level at the operators ear, dB(A)	91
Vibration levels, $a_{hw}$ (see note 3)	
Handle right, $m/s^2$	3,4
Handle left, $m/s^2$	3,6

Note 1: Noise emissions in the environment measured as sound power ( $L_{WA}$ ) in conformity with EC directive 2000/14/EC.

Note 2: Noise pressure level according to EN 13862. Reported data for noise pressure level has a typical statistical dispersion (standard deviation) of 1.0 dB(A).

Note 3: Vibration level according to EN 13862. Reported data for vibration level has a typical statistical dispersion (standard deviation) of 1  $m/s^2$ .

## TECHNICAL DATA

**CALIFORNIA AIR RESOURCES BOARD (CARB):** This machine is considered a preempt Off-Road Application as relating to CARB standards. Under construction equipment, and in particular, as a Saws : concrete, masonry, cutoff, with engine power less than 19KW (25hp), CARB standards do not apply to this machine.

For more information see the website

<http://www.arb.ca.gov/msprog/offroad/preempt.htm>

## EC DECLARATION OF CONFORMITY

Husqvarna AB, SE-433 81 Göteborg, Sweden, tel: +46-31-949000, declares under sole responsibility that the **Husqvarna Soff-Cut 4200** dating from 2010 serial numbers and onwards (the year is clearly stated on the rating plate, followed by the serial number), complies with the requirements of the COUNCIL'S DIRECTIVE:

- of May 17, 2006 "relating to machinery" 2006/42/EC
- of December 15, 2004 "relating to electromagnetic compatibility" 2004/108/EC.
- of May 8, 2000 "relating to the noise emissions in the environment" 2000/14/EC.

The following standards have been applied: EN ISO 12100:2003, EN 55014-1:2006, EN 55014-2/A1:2001, EN 61000-3-2:2006, EN 61000-3-3/A1/A2:2005, EN 13862/A1:2009.

Husqvarna December 29, 2009



Henric Andersson

Vice President, Head of Power Cutters and Construction Equipment

(Authorized representative for Husqvarna AB and responsible for technical documentation.)



[www.husqvarnacp.com](http://www.husqvarnacp.com)

Original instructions

1153474-26



2022-02-01