

**Operator's manual**  
**K 1260**  
**K 1260 Rail**

Please read the operator's manual carefully and make sure you understand the instructions before using the machine.

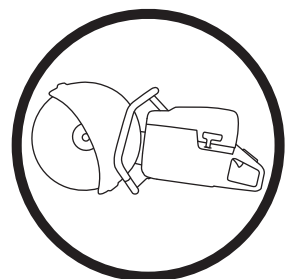

**English**

# KEY TO SYMBOLS

## Symbols on the machine

**WARNING!** The machine can be a dangerous tool if used incorrectly or carelessly, which can cause serious or fatal injury to the operator or others.

Please read the operator's manual carefully and make sure you understand the instructions before using the machine.

Wear personal protective equipment. See instructions under the heading "Personal protective equipment".

This product is in accordance with applicable EC directives.

**WARNING!** Dust forms when cutting, this can cause injuries if inhaled. Use an approved breathing mask. Avoid inhaling petrol fumes and exhaust fumes. Always provide for good ventilation.

**WARNING!** Kickbacks can be sudden, rapid and violent and can cause life threatening injuries. Read and understand the instructions in the manual before using the machine.

**WARNING!** Sparks from the cutting blade can cause fire in combustible materials such as: petrol (gas), wood, dry grass etc.

Choke

Decompression valve

Refuelling, petrol/oil mix

Noise emission to the environment according to the European Community's Directive. The machine's emission is specified in chapter Technical data and on label.

**Other symbols/decals on the machine refer to special certification requirements for certain markets.**

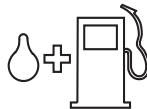

## Explanation of warning levels

The warnings are graded in three levels.

### WARNING!



**WARNING!** Used if there is a risk of serious injury or death for the operator or damage to the surroundings if the instructions in the manual are not followed.

### CAUTION!



**CAUTION!** Used if there is a risk of injury to the operator or damage to the surroundings if the instructions in the manual are not followed.

### NOTICE!



**NOTICE!** Used if there is a risk of damage to materials or the machine if the instructions in the manual are not followed.

---

# CONTENTS

---

## Contents

### KEY TO SYMBOLS

Symbols on the machine .....	2
Explanation of warning levels .....	2

### CONTENTS

Contents .....	3
----------------	---

### PRESENTATION

Dear Customer, .....	4
Features .....	4

### WHAT IS WHAT?

What is what on the power cutter - K 1260? .....	5
--	---

### WHAT IS WHAT?

What is what on the power cutter - K 1260 Rail? .....	6
---	---

### MACHINE'S SAFETY EQUIPMENT

General .....	7
---------------	---

### CUTTING BLADES

General .....	9
Abrasive blades .....	9
Diamond blades .....	10
Transport and storage .....	10

### ASSEMBLING AND ADJUSTMENTS

General .....	11
Checking the drive shaft and flange washers .....	11
Checking the bushing .....	11
Checking the direction of the blade rotation .....	11
Fitting the cutting blade .....	11
Blade guard .....	11
Reversible cutting head .....	12

### FUEL HANDLING

General .....	13
Fuel .....	13
Fueling .....	13
Transport and storage .....	13

### OPERATING

Protective equipment .....	14
General safety precautions .....	14
Transport and storage .....	18

### STARTING AND STOPPING

Before starting .....	19
Starting .....	19
Stopping .....	20

### MAINTENANCE

General .....	21
Maintenance schedule .....	21
Cleaning .....	22
Functional inspection .....	22

### TECHNICAL DATA

Technical data .....	26
Cutting equipment .....	26
EC-declaration of conformity .....	27

---

# PRESENTATION

---

## Dear Customer,

Thank you for choosing a Husqvarna product!

It is our wish that you will be satisfied with your product and that it will be your companion for a long time. A purchase of one of our products gives you access to professional help with repairs and services. If the retailer who sells your machine is not one of our authorised dealers, ask him for the address of your nearest service workshop.

This operator's manual is a valuable document. Make sure it is always at hand at the work place. By following its content (using, service, maintenance etc) the life span and the second-hand value of the machine can be extended. If you will sell this machine, make sure that the buyer will get the operator's manual.

## More than 300 years of innovation

Husqvarna AB is a Swedish company based on a tradition that dates back to 1689, when the Swedish King Charles XI ordered the construction of a factory for production of muskets. At that time, the foundation was already laid for the engineering skills behind the development of some of the world's leading products in areas such as hunting weapons, bicycles, motorcycles, domestic appliances, sewing machines and outdoor products.

Husqvarna is the global leader in outdoor power products for forestry, park maintenance and lawn and garden care, as well as cutting equipment and diamond tools for the construction and stone industries.

## User responsibility

It is the owner's/employer's responsibility that the operator has sufficient knowledge about how to use the machine safely. Supervisors and operators must have read and understood the Operator's Manual. They must be aware of:

- The machine's safety instructions.
- The machine's range of applications and limitations.
- How the machine is to be used and maintained.

National legislation could regulate the use of this machine. Find out what legislation is applicable in the place where you work before you start using the machine.

## The manufacturer's reservation

All information and all data in the Operator's Manual were applicable at the time the Operator's Manual was sent to print.

Husqvarna AB has a policy of continuous product development and therefore reserves the right to modify the design and appearance of products without prior notice.

## Features

Values such as high performance, reliability, innovative technology, advanced technical solutions and environmental considerations distinguish Husqvarna's products.

Some of the unique features of your product are described below.

### Active Air Filtration™

Centrifugal air cleaning for longer service life and longer service intervals.

### SmartCarb™

Built-in automatic filter compensation maintains high power and reduces fuel consumption.

### EasyStart

The engine and starter are designed to ensure quick and easy starting of the machine. Reduces the pull resistance in the starter cord with up to 40%. (Reduces the compression during starting.)

### DEX (K 1260)

Low flushing wet cutting kit for effective dust handling.

### Efficient vibration damping system

Efficient vibration dampers spare arms and hands.

### Reversible cutting head (K 1260)

The machine is fitted with a reversible cutting head allowing cutting close to a wall or at ground level, restricted only by the thickness of the blade guard.

### Rail fixture - RA 10, RA 10 S (K 1260 Rail)

Is attached to the rail and drives the cut perpendicular to the fixture for a straighter cut.

# WHAT IS WHAT?

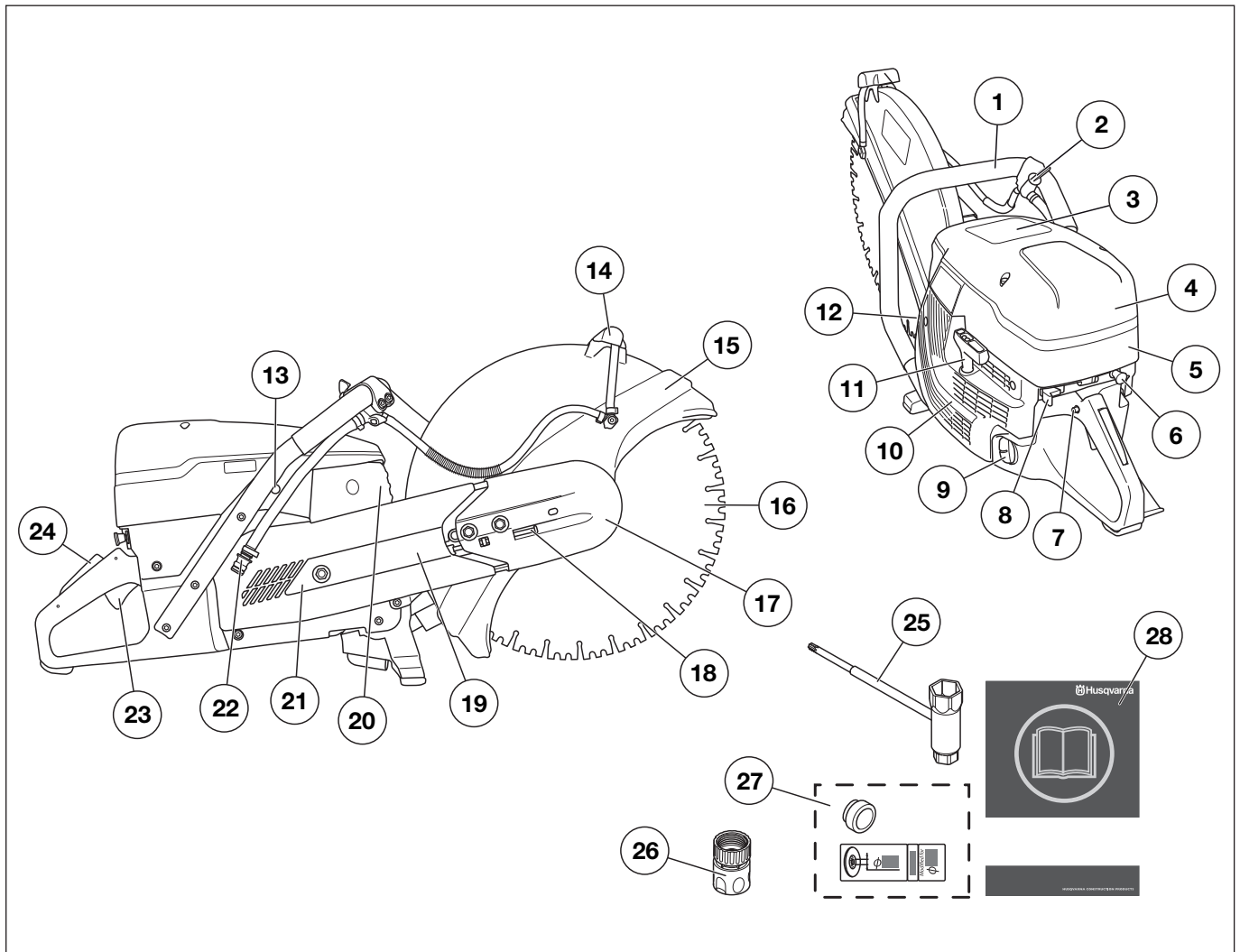

## What is what on the power cutter - K 1260?

- |                                 |                                 |
|---------------------------------|---------------------------------|
| 1 Front handle                  | 15 Blade guard                  |
| 2 Water tap                     | 16 Cutting blade                |
| 3 Information and warning decal | 17 Cutting head                 |
| 4 Air filter cover              | 18 Belt tensioner               |
| 5 Cylinder cover                | 19 Cutting arm                  |
| 6 Choke control                 | 20 Muffler                      |
| 7 Start throttle lock           | 21 Belt guard                   |
| 8 Stop switch                   | 22 Water connection with filter |
| 9 Fuel cap                      | 23 Throttle trigger             |
| 10 Starter                      | 24 Throttle lockout             |
| 11 Starter handle               | 25 Combination spanner          |
| 12 Rating plate                 | 26 Water connector, GARDENA®    |
| 13 Decompression valve          | 27 Bushing + decal              |
| 14 Adjustment handle for guard  | 28 Operator's manual            |

# WHAT IS WHAT?

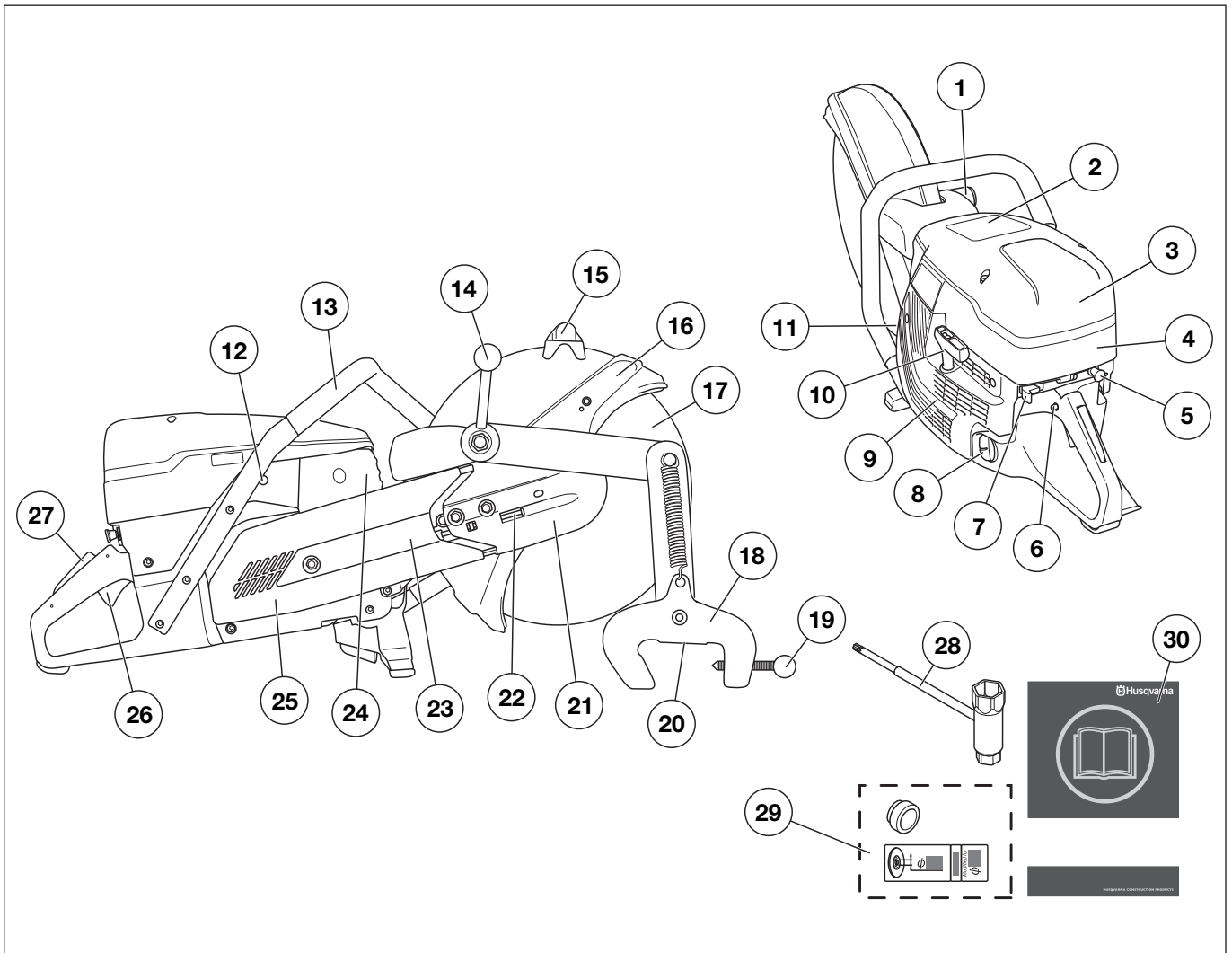

## What is what on the power cutter - K 1260 Rail?

- |                                 |                        |
|---------------------------------|------------------------|
| 1 Mounting for rail fixture     | 16 Blade guard         |
| 2 Information and warning decal | 17 Cutting blade       |
| 3 Air filter cover              | 18 Rail fixture        |
| 4 Cylinder cover                | 19 Rail lock handle    |
| 5 Choke control                 | 20 Cutting guide       |
| 6 Start throttle lock           | 21 Cutting head        |
| 7 Stop switch                   | 22 Belt tensioner      |
| 8 Fuel cap                      | 23 Cutting arm         |
| 9 Starter                       | 24 Muffler             |
| 10 Starter handle               | 25 Belt guard          |
| 11 Rating plate                 | 26 Throttle trigger    |
| 12 Decompression valve          | 27 Throttle lockout    |
| 13 Front handle                 | 28 Combination spanner |
| 14 Power cutter lock handle     | 29 Bushing + decal     |
| 15 Adjustment handle for guard  | 30 Operator's manual   |

# MACHINE'S SAFETY EQUIPMENT

## General



**WARNING! Never use a machine that has faulty safety equipment! If your machine fails any of these checks contact your service agent to get it repaired.**

**The engine should be switched off, and the stop switch in STOP position.**

This section describes the machine's safety equipment, its purpose, and how checks and maintenance should be carried out to ensure that it operates correctly.

## Throttle lockout

The throttle trigger lock is designed to prevent accidental operation of the throttle. When the lock (A) is pressed in this releases the throttle (B).

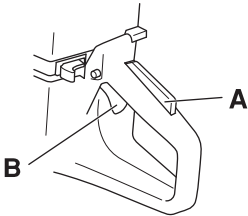

The trigger lock remains pressed in as long as the throttle is pressed. When the grip on the handle is released the throttle trigger and the throttle trigger lock both return to their original positions. This is controlled by two independent return spring systems. This means that the throttle trigger is automatically locked in the idle position.

## Checking the throttle lockout

- Make sure the throttle control is locked at the idle setting when the throttle lockout is released.

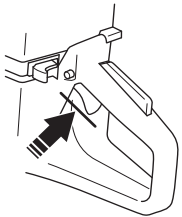

- Press the throttle lockout and make sure it returns to its original position when you release it.

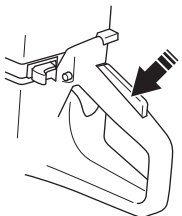

- Check that the throttle trigger and throttle lockout move freely and that the return springs work properly.

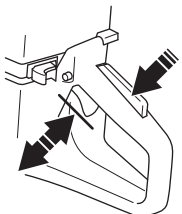

- Start the power cutter and apply full throttle. Release the throttle control and check that the cutting blade stops and remains stationary. If the cutting blade rotates when the throttle is in the idle position you should check the carburettor's idle adjustment. See instructions in the section "Maintenance".

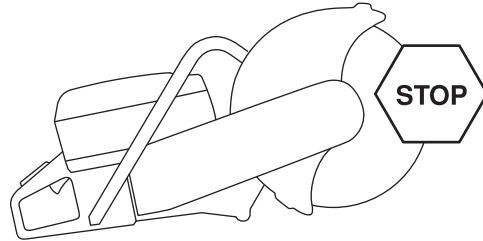

## Stop switch

Use the stop switch to switch off the engine.

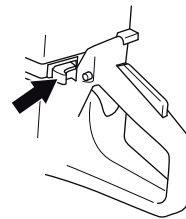

## Checking the stop switch

- Start the engine and make sure the engine stops when you move the stop switch to the stop setting.

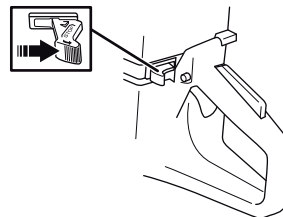

## Blade guard



**WARNING! Always check that the guard is correctly fitted before starting the machine.**

This guard is fitted above the cutting blade and is designed to prevent parts of the blade or cutting fragments from being thrown towards the user.

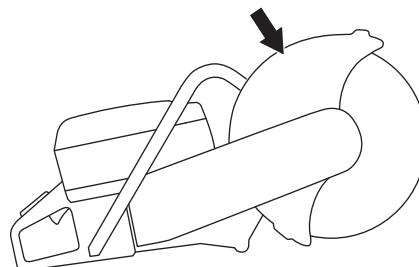

## Checking the blade guard

- Check that the guard over the cutting blade is not cracked or damaged in any other way. Replace when damaged.
- Check that the cutting blade is fitted correctly and does not show signs of damage. A damaged cutting blade can cause personal injury.

# MACHINE'S SAFETY EQUIPMENT

## Vibration damping system



**WARNING!** Overexposure to vibration can lead to circulatory damage or nerve damage in people who have impaired circulation. Contact your doctor if you experience symptoms of overexposure to vibration. Such symptoms include numbness, loss of feeling, tingling, pricking, pain, loss of strength, changes in skin colour or condition. These symptoms normally appear in the fingers, hands or wrists. These symptoms may be increased in cold temperatures.

- Your machine is equipped with a vibration damping system that is designed to minimize vibration and make operation easier.
- The machine's vibration damping system reduces the transfer of vibration between the engine unit/cutting equipment and the machine's handle unit. The engine body, including the cutting equipment, is insulated from the handles by vibration damping units.

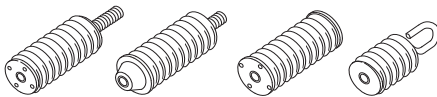

### Checking the vibration damping system



**WARNING!** The engine should be switched off, and the stop switch in STOP position.

- Check the vibration damping units regularly for cracks or deformation. Replace them if damaged.
- Check that the vibration damping element is securely attached between the engine unit and handle unit.

## Muffler



**WARNING!** Never use a machine without a muffler, or with a faulty muffler. A damaged muffler may substantially increase the noise level and the fire hazard. Keep fire fighting equipment handy.

The muffler gets very hot during and after use. This also applies during idling. Be aware of the fire hazard, especially when working near flammable substances and/or vapours.

The muffler is designed to keep noise levels to a minimum and to direct exhaust fumes away from the user.

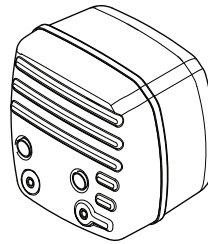

### Inspecting the muffler

Check regularly that the muffler is complete and secured correctly.



# CUTTING BLADES

## General



**WARNING! A cutting blade may burst and cause injury to the operator.**

- Cutting blades are available in two basic designs; abrasive blades and diamond blades.

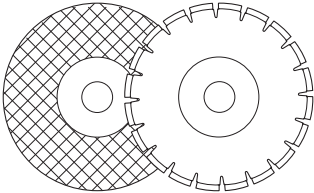

- High-quality blades are often most economical. Lower quality blades often have inferior cutting capacity and a shorter service life, which results in a higher cost in relation to the quantity of material that is cut.
- Make sure that the right bushing is used for the cutting blade to be fitted on the machine. See the instructions under the heading Assembling the cutting blade.

## Suitable cutting blades

Cutting blades	K 1260	K 1260 Rail
Abrasive blades	Yes*	Yes*
Abrasive blades for rail cutting	No	Yes*
Diamond blades	Yes	Yes**
Toothed blades	No	No

\*Without water

\*\*Diamond blades for dry cutting

## Cutting blades for different materials



**WARNING! Never use a cutting blade for any other materials than that it was intended for.**

**Cutting plastics with a diamond blade can cause kickback when the material melts due to the heat produced when cutting and sticks to the blade. Never cut plastic materials with a diamond blade!**

**Cutting in metal generates sparks that may cause fire. Do not use the machine near to ignitable substances or gases.**

Follow the instructions supplied with the cutting blade concerning the suitability of the blade for various applications, or consult your dealer in case of doubts.

	Concrete	Metal	Rail	Plastic	Cast iron
<b>Abrasive blades</b>	X	X		X	X
<b>Abrasive blades for rail cutting</b>			X		
<b>Diamond blades</b>	X	X*			X*

\* Only specialty blades.

## Hand-held, high-speed machines



**WARNING! Never use a cutting blade at a lower speed rating than that of the power cutter. Only use cutting blades intended for high speed handheld power cutters.**

- Our cutting blades are manufactured for high-speed, portable power cutters.
- Check that the blade is approved for the same or higher speed according to the approval plate of the engine. Never use a cutting blade with a lower speed rating than that of the power cutter.

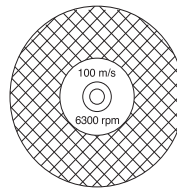

## Blade vibration

- The blade can become out-of-round and vibrate if an excessive feed pressure is used.
- A lower feed pressure can stop the vibration. Otherwise replace the blade.

## Abrasive blades



**WARNING! Do not use abrasive blades with water. The strength is impaired when abrasive blades are exposed to water or moisture, which results in an increased risk of the blade breaking.**

- The cutting material on abrasive blades consists of grit bonded using an organic binder. "Reinforced blades" are made up of a fabric or fibre base that prevents total breakage at maximum working speed if the blade should be cracked or damaged.
- A cutting blade's performance is determined by the type and size of abrasive grain, and the type and hardness of the bonding agent.

# CUTTING BLADES

- Ensure the blade is not cracked or damaged in any other way.

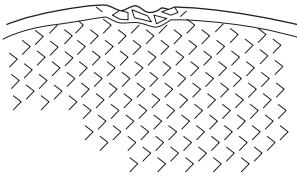

- Test the abrasive blade by hanging it on your finger and tapping it lightly with a screwdriver or the like. If the blade does not produce a resonant, ringing sound it is damaged.

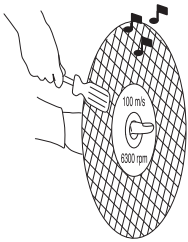

## Abrasive blades for different materials

Blade type	Material
Concrete blade	Concrete, asphalt, stone masonry, cast iron, aluminium, copper, brass, cables, rubber, plastic, etc.
Metal blade	Steel, steel alloys and other hard metals.
Blade for rail cutting	Rail

## Rail cutting

Only use specially intended cutting blades for rail cutting.

## Diamond blades

### General



**WARNING! Cutting plastics with a diamond blade can cause kickback when the material melts due to the heat produced when cutting and sticks to the blade.**

**Diamond blades get very hot when used. An overheated blade is a result of improper use, and may cause deformation of the blade, resulting in damage and injuries.**

**Cutting in metal generates sparks that may cause fire. Do not use the machine near to ignitable substances or gases.**

- Diamond blades consist of a steel core provided with segments that contain industrial diamonds.
- Diamond blades ensure lower costs per cutting operation, fewer blade changes and a constant cutting depth.

- When using diamond blades make sure that it rotates in the direction indicated by the arrow on the blade.

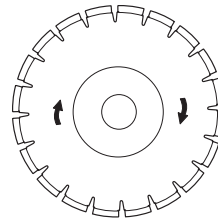

## Diamond blades for different materials

- Diamond blades are ideal for masonry, reinforced concrete and other composite materials.
- Diamond blades are available in several hardness classes.
- Special blades should be used when cutting metal. Ask your dealer for help in choosing the right product.

## Sharpening diamond blades

- Always use a sharp diamond blade.
- Diamond blades can become dull when the wrong feeding pressure is used or when cutting certain materials such as heavily reinforced concrete. Working with a blunt diamond blade causes overheating, which can result in the diamond segments coming loose.
- Sharpen the blade by cutting in a soft material such as sandstone or brick.

## Diamond blades for dry cutting

- Diamond blades for dry cutting can be used both with and without water cooling.
- When dry cutting, lift the blade out from the cut every 30–60 seconds and let it rotate in the air for 10 seconds to let it cool. If this is not done, the blade may be overheated.

## Diamond blades for wet cutting

- Diamond blades for wet cutting must be water cooled. If this is not done, the blade may be overheated.
- Water cooling cools the blade and increases its service life while also reducing the formation of dust.

## Transport and storage

- Do not store or transport the power cutter with the cutting blade fitted. All blades should be removed from the cutter after use and stored carefully.
- Store cutting blades in dry, frost free conditions. Special care should be taken with abrasive blades. Abrasive blades must be stored on a flat, level surface. If an abrasive blade is stored in humid conditions, this can cause imbalance and result in injury.
- Inspect new blades for transport or storage damage.

# ASSEMBLING AND ADJUSTMENTS

## General



**WARNING!** The engine should be switched off, and the stop switch in STOP position.

Husqvarna's blades are approved for hand-held power cutters.

## Checking the drive shaft and flange washers

When the blade is replaced with a new one, check the flange washers and the drive shaft.

- Check that the threads on the drive shaft are undamaged.
- Check that the contact surfaces on the blade and the flange washers are undamaged, of the correct dimension, clean, and that they run properly on the drive axle.

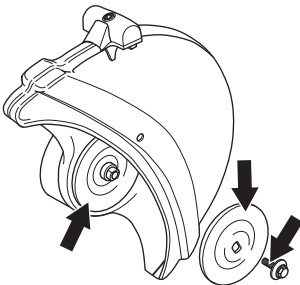

Do not use warped, notched, indented or dirty flange washers. Do not use different dimensions of flange washers.

## Checking the bushing

Bushings are used to fit the machine to the centre hole in the cutting blade. The machine is supplied with two different sized bushings, 20 mm (25/32") and 25, 4 mm (1"). A plate on the blade guard indicates which bushing has been factory-fitted.

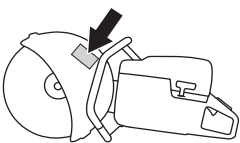

When replacing the bushing, the labeling of the machine must be updated with the supplied decal.

- Check that the bushing on the machine's spindle shaft corresponds with the centre hole of the cutting blade. The blades are marked with the diameter of the centre hole.

## Checking the direction of the blade rotation

- When using diamond blades make sure that it rotates in the direction indicated by the arrow on the blade. The direction of rotation for the machine is shown by arrows on the cutting arm.

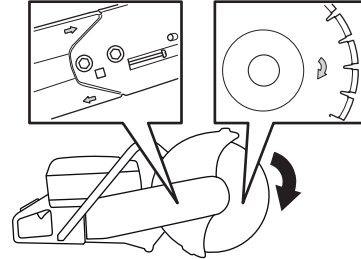

## Fitting the cutting blade

- The blade is placed on the bushing (A) between the inner flange washer (B) and the flange washer (C). The flange washer is turned so that it fits on the axle.

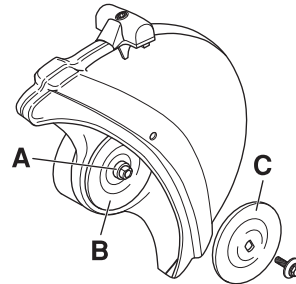

- Lock the shaft. Insert a tool in the hole in the cutting head and rotate the blade until it is locked.



- Tightening torque for the bolt holding the blade is: 15-25 Nm (130-215 in.lb).

## Blade guard

The guard for the cutting equipment should be adjusted so that the rear section is flush with the work piece. Spatter and sparks from the material being cut are then collected up by the guard and led away from the user.

The blade guard is friction locked.

- Press the ends of the guard against the work piece or adjust the guard with the adjustment handle. The guard must always be fitted on the machine.

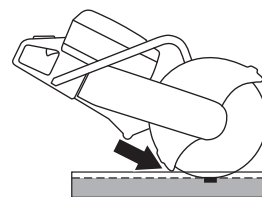

# ASSEMBLING AND ADJUSTMENTS

## Reversible cutting head (K 1260)

The machine is fitted with a reversible cutting head allowing cutting close to a wall or at ground level, restricted only by the thickness of the blade guard.

There is an increased risk for kickback when cutting with the cutting head reversed. The cutting blade is further away from the centre of the machine which means the handle and the cutting blade are no longer in alignment. It is more difficult to restrain the machine if the blade gets jammed or stuck in its kickback danger zone. See under the "Kickback" heading in the "Operating" section for additional information.

Some of the machine's good ergonomic features may also be jeopardised. Cutting with the cutting head reversed should only occur with cuts that are not possible in a standard manner.

- First release the two bolts and then the adjuster screw to release the belt tension.

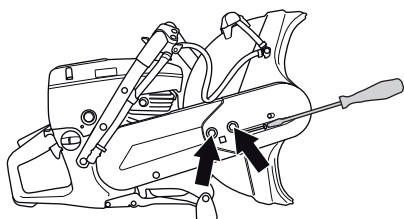

- Now unscrew the bolts and dismantle the belt guard.

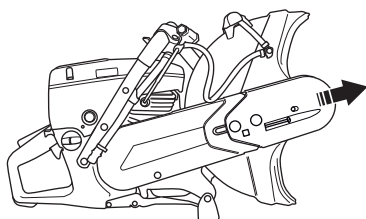

- Disconnect the water hose from the blade guard.
- Remove the belt from the belt pulley.

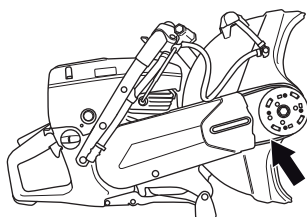

- The cutting head is now loose and can be removed from the machine.
- Remove the cutting head and attach it to the other side of the cutting arm.

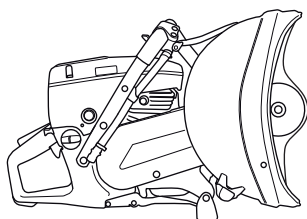

- Fit the belt guard to the reversed cutting head.
- Tighten the drive belt. See instructions in the section "Maintenance".
- A longer water hose has to be fitted to the machine if wet cutting is carried out.

# FUEL HANDLING

## General



**WARNING! Running an engine in a confined or badly ventilated area can result in death due to asphyxiation or carbon monoxide poisoning. Use fans to ensure proper air circulation when working in trenches or ditches deeper than one meter.**

**Fuel and fuel fumes are highly inflammable and can cause serious injury when inhaled or allowed to come in contact with the skin. For this reason observe caution when handling fuel and make sure there is adequate ventilation.**

**The exhaust fumes from the engine are hot and may contain sparks which can start a fire. Never start the machine indoors or near combustible material!**

**Do not smoke and do not place any hot objects in the vicinity of fuel.**

## Fuel

**NOTICE!** The machine is equipped with a two-stroke engine and must always be run using a mixture of petrol and two-stroke oil. It is important to accurately measure the amount of oil to be mixed to ensure that the correct mixture is obtained. When mixing small amounts of fuel, even small inaccuracies can drastically affect the ratio of the mixture.

## Petrol

- Use good quality unleaded or leaded petrol.
- The lowest octane recommended is 90 (RON). If you run the engine on a lower octane grade than 90 so-called knocking can occur. This gives rise to a high engine temperature, which can result in serious engine damage.
- When working at continuous high revs a higher octane rating is recommended.

## Environment fuel

The use of environment fuel (alkylate fuel), or environment fuel for four-stroke engines blended with two-stroke oil as set out below is recommended.

Ethanol blended fuel, E10 may be used (max 10% ethanol blend). Using ethanol blends higher than E10 will create lean running condition which can cause engine damage.

## Two-stroke oil

- For best results and performance use HUSQVARNA two-stroke engine oil, which is specially formulated for our air-cooled two-stroke engines.
- Never use two-stroke oil intended for water-cooled engines, sometimes referred to as outboard oil (rated TCW).
- Never use oil intended for four-stroke engines.

## Mixing

- Always mix the petrol and oil in a clean container intended for fuel.
- Always start by filling half the amount of the petrol to be used. Then add the entire amount of oil. Mix (shake) the fuel mixture. Add the remaining amount of petrol.
- Mix (shake) the fuel mixture thoroughly before filling the machine's fuel tank.
- Do not mix more than one month's supply of fuel at a time.

## Mixing ratio

- 1:50 (2%) with HUSQVARNA two-stroke oil or equivalent.
- 1:33 (3%) with oils class JASO FB or ISO EGB formulated for air-cooled, two-stroke engines.

Petrol, litre	Two-stroke oil, litre	
	2% (1:50)	3% (1:33)
5	0,10	0,15
10	0,20	0,30
15	0,30	0,45
20	0,40	0,60

## Fueling



**WARNING! Always stop the engine and let it cool for a few minutes before refuelling. The engine should be switched off, and the stop switch in STOP position.**

**When refuelling, open the fuel cap slowly so that any excess pressure is released gently.**

**Clean the area around the fuel cap.**

**Tighten the fuel cap carefully after refuelling. Negligence may lead to the start of a fire.**

**Move the machine at least 3 m from the refuelling point before starting it.**

Never start the machine:

- If you have spilt fuel or engine oil on the machine. Wipe off the spill and allow the remaining fuel to evaporate.
- If you have spilt fuel on yourself or your clothes, change your clothes. Wash any part of your body that has come in contact with fuel. Use soap and water.
- If the machine is leaking fuel. Check regularly for leaks from the fuel cap and fuel lines.

## Transport and storage

- Store and transport the machine and fuel so that there is no risk of any leakage or fumes coming into contact with sparks or naked flames, for example, from electrical machinery, electric motors, electrical relays/switches or boilers.
- When storing and transporting fuel always use approved containers intended for this purpose.

## Long-term storage

- When storing the machine for long periods the fuel tank must be emptied. Contact your local petrol station to find out where to dispose of excess fuel.

# OPERATING

## Protective equipment

### General

- Do not use the machine unless you are able to call for help in the event of an accident.

### Personal protective equipment

You must use approved personal protective equipment whenever you use the machine. Personal protective equipment cannot eliminate the risk of injury but it will reduce the degree of injury if an accident does happen. Ask your dealer for help in choosing the right equipment.



**WARNING!** The use of products such as cutters, grinders, drills, that sand or form material can generate dust and vapours which may contain hazardous chemicals. Check the nature of the material you intend to process and use an appropriate breathing mask.

Long-term exposure to noise can result in permanent hearing impairment. So always use approved hearing protection. Listen out for warning signals or shouts when you are wearing hearing protection. Always remove your hearing protection as soon as the engine stops.

Always wear:

- Approved protective helmet
- Hearing protection
- Approved eye protection. If you use a face shield then you must also wear approved protective goggles. Approved protective goggles must comply with standard ANSI Z87.1 in the USA or EN 166 in EU countries. Visors must comply with standard EN 1731.
- Breathing mask
- Heavy-duty, firm grip gloves.
- Tight-fitting, heavy-duty and comfortable clothing that permits full freedom of movement.
- Boots with steel toe-caps and non-slip sole.

### Other protective equipment



**CAUTION!** Sparks may appear and start a fire when you work with the machine. Always keep fire fighting equipment handy.

- Fire Extinguisher
- Always have a first aid kit nearby.

## General safety precautions

This section describes basic safety directions for using the machine. This information is never a substitute for professional skills and experience.

- Please read the operator's manual carefully and make sure you understand the instructions before using the machine.
- Keep in mind that it is you, the operator that is responsible for not exposing people or their property to accidents or hazards.
- The machine must be kept clean. Signs and stickers must be fully legible.

### Always use common sense

It is not possible to cover every conceivable situation you can face. Always exercise care and use your common sense. If you get into a situation where you feel unsafe, stop and seek expert advice. Contact your dealer, service agent or an experienced user. Do not attempt any task that you feel unsure of!



**WARNING!** The machine can be a dangerous tool if used incorrectly or carelessly, which can cause serious or fatal injury to the operator or others.

Never allow children or other persons not trained in the use of the machine to use or service it.

Never allow anyone else to use the machine without first ensuring that they have understood the contents of the operator's manual.

Never use the machine if you are fatigued, while under the influence of alcohol or drugs, medication or anything that could affect your vision, alertness, coordination or judgement.



**WARNING!** Unauthorized modifications and/or accessories may lead to serious injury or death to the user or others. Under no circumstances may the design of the machine be modified without the permission of the manufacturer.

Do not modify this product or use it if it appears to have been modified by others.

Never use a machine that is faulty. Carry out the checks, maintenance and service instructions described in this manual. Some maintenance and service measures must be carried out by trained and qualified specialists. See instructions under the heading Maintenance.

Always use genuine accessories.



**WARNING!** This machine produces an electromagnetic field during operation. This field may under some circumstances interfere with active or passive medical implants. To reduce the risk of serious or fatal injury, we recommend persons with medical implants to consult their physician and the medical implant manufacturer before operating this machine.

# OPERATING

## Work area safety



**WARNING!** The safety distance for the power cutter is 15 metres. You are responsible to ensure that animals and onlookers are not within the working area. Do not start cutting until the working area is clear and you are standing firmly.

- Observe your surroundings to ensure that nothing can affect your control of the machine.
- Ensure that no one/nothing can come into contact with the cutting equipment or be hit by parts if the blade breaks.
- Do not use the machine in bad weather, such as dense fog, heavy rain, strong wind, intense cold, etc. Working in bad weather is tiring and can lead to dangerous conditions, e.g. slippery surfaces.
- Never start to work with the power cutter before the working area is clear and you have a firm foothold. Look out for any obstacles with unexpected movement. Ensure when cutting that no material can become loose and fall, causing operating injury. Take great care when working on sloping ground.
- Ensure that the working area is sufficiently illuminated to create a safe working environment.
- Make sure that no pipes or electrical cables are routed in the working area or in the material to be cut.

## Basic working techniques



**WARNING!** Do not pull the power cutter to one side, this can cause the blade to jam or break resulting in injury to people.

**Under all circumstances avoid grinding using the side of the blade; it will almost certainly be damaged, break and can cause immense damage. Only use the cutting section.**

**Cutting plastics with a diamond blade can cause kickback when the material melts due to the heat produced when cutting and sticks to the blade. Never cut plastic materials with a diamond blade!**

**Cutting in metal generates sparks that may cause fire.**

- Do not use the machine near to ignitable substances or gases.
- The machine is designed and intended for cutting with abrasive blades or diamond blades intended for high speed handheld machines. The machine shall not be used with any other type of blade, or for any other type of cutting.
- Check that the cutting blade is fitted correctly and does not show signs of damage. See the instructions in the sections "Cutting blades" and "Assembly and settings".
- Check that the correct cutting blade is used for the application in question. See instructions in the section "Cutting blades".

- Never cut asbestos materials!
- Maintain a safe distance from the cutting blade when the engine is running.
- Never leave the machine unsupervised with the motor running.
- Never move the machine when the cutting equipment is rotating.
- The guard for the cutting equipment should be adjusted so that the rear section is flush with the work piece. Spatter and sparks from the material being cut are then collected up by the guard and led away from the user. The guards for the cutting equipment must always be fitted when the machine is running.

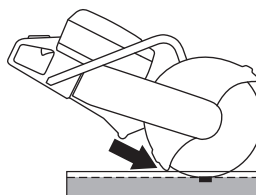

- Never use the kickback zone of the blade for cutting. See instructions under the heading "Kickback".
- Keep a good balance and a firm foothold.
- Never cut above shoulder height. Never cut from a ladder. Use a platform or scaffold when working at high altitude.



- Always hold the machine in a firm grip with both hands. Hold it so that the thumbs and fingers grip round the handles.

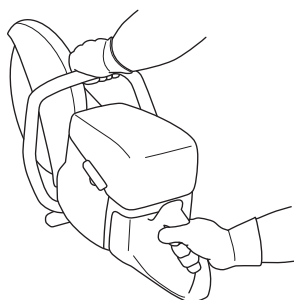

- Stand at a comfortable distance from the work piece.
- Check that the blade is not in contact with anything when the machine is started
- Apply the cutting blade gently with high rotating speed (full throttle) Maintain full speed until cutting is complete.
- Let the machine work without forcing or pressing the blade.

# OPERATING

- Feed down the machine in line with the blade. Pressure from the side can damage the blade and is very dangerous.

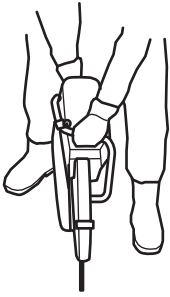

- Move the blade slowly forwards and backwards to achieve a small contact area between the blade and the material to be cut. This reduces the temperature of the blade and ensures effective cutting.

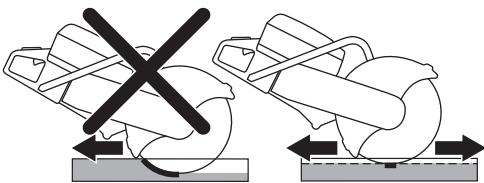

## Managing dust (Applies only for K 1260)

The machine is fitted with DEX (Dust Extinguisher), a low flushing water kit that offers maximum dust suppression.

Use wet cutting blades with DEX when possible for optimal dust management. See instructions in the section "Cutting blades".

Adjust water flow using the tap to bind the cutting dust. The volume of water required varies depending on the type of job at hand.

If water hoses loosen from their supply sources, this indicates that the machine is connected to a water pressure that is too high. See instructions under the "Technical data" heading for recommended water pressure.

## Rail cutting

### General

**NOTICE!** The rail fixture must not be mounted on the machine during transport or when handling the equipment. The rail fixture is a precision tool that can be damaged if not handled with care which results in less precise cuts.

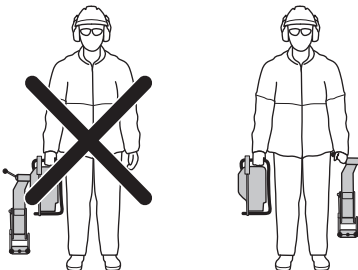

## Assembling the rail fixture

- Mount the rail fixture onto the rail. Screw the lock handle tight.

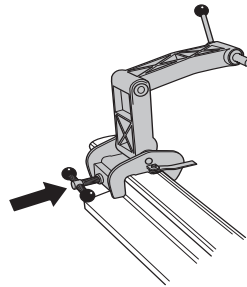

- Mount the power cutter with its right side to the fixture. The mounting on the power cutter is fitted closest to the spindle on the cutting blade when assembling from this side. Assembly should therefore be carried out primarily from this direction.

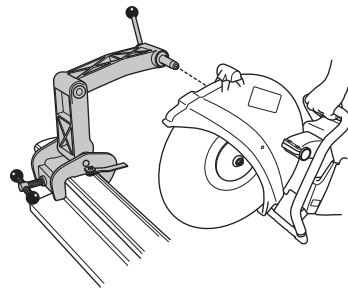

**NOTICE!** The rail fixture must be first fitted to the rail before the power cutter is fitted to the rail fixture. This is done to guarantee that the fixture is attached at right angles to the rail.

## Cutting guide

The cutting guide is used to facilitate guiding the blade to where the cut is to be made. The first time you use the power cutter, you must cut the guide.

- Fold out the cutting guide.
- Fix the cutting guide parallel to the rail in an appropriate manner.

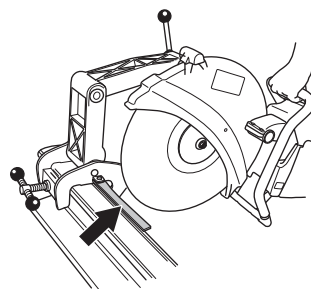

- Carefully cut off the guide.

## Work procedure

- Fold out the cutting guide.
- Align the saw cut and fold in the guide.



# OPERATING

- Begin the cutting process by swinging the machine back and forth horizontally. This way the cutting blade's contact surface to the rail is minimised, which reduces the risk of the blade glazing.

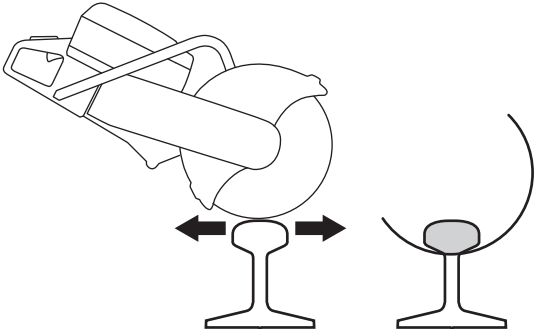

- When you have cut through the head (A), you continue cutting the rib (B) and foot (C).



If the cut cannot be completed from one side, the power cutter must be turned around.

- Shut off the machine.
- Dismantle the power cutter from the fixture.
- Fit the power cutter with its left side to the rail fixture.

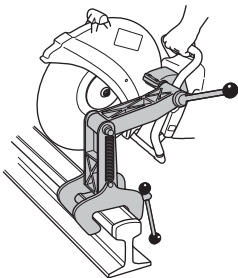

- Guide the cutting blade down towards the rail and check that the cutting blade is centred in the cut. If necessary, adjust the movable bushing so that the blade ends up centred in the middle of the cut.

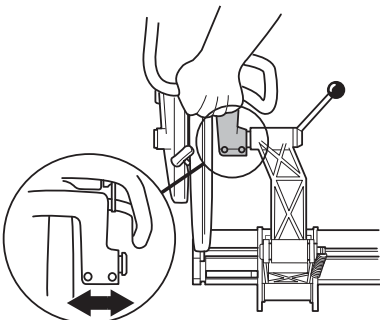

- Now cutting can proceed.



## General tips

- Only use specially intended cutting blades for rail cutting.
- Apply full throttle until the blade reaches top speed. Reduce throttle to drop below the speed limitation which reduces cutting blade vibrations when initiating a cut to thereby produce straighter cuts. Apply full throttle and maintain full speed until the cutting process is completed.
- Hold the machine's handle so that the hands are in line with the cutting blade. This to achieve maximum cutting speed, blade service life and a straight cut.
- When performing the cutting process correctly, it takes about one minute to cut a 50 kg/m-rail and about one and a half minute to cut 60 kg/m-rail. If it takes longer, review your cutting technique. Problems which arise are often the result of incorrect cutting technique or poor cutting blades.

## Kickback



**WARNING! Kickbacks are sudden and can be very violent. The power cutter can be thrown up and back towards the user in a rotating motion causing serious or even fatal injury. It is vital to understand what causes kickback and how to avoid it before using the machine.**

Kickback is the sudden upward motion that can occur if the blade is pinched or stalled in the kickback zone. Most kickbacks are small and pose little danger. However a kickback can also be very violent and throw the power cutter up and back towards the user in a rotating motion causing serious or even fatal injury.

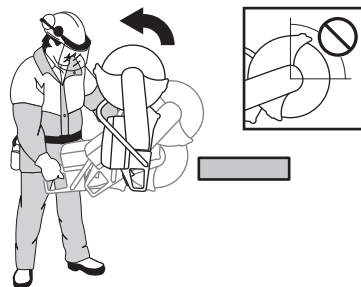

## Reactive force

A reactive force is always present when cutting. The force pulls the machine in the opposite direction to the blade rotation. Most of the time this force is insignificant. If the blade is pinched or stalled the reactive force will be strong and you might not be able to control the power cutter.

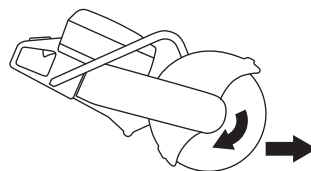

# OPERATING

## Kickback zone

Never use the kickback zone of the blade for cutting. If the blade is pinched or stalled in the kickback zone, the reactive force will push the power cutter up and back towards the user in a rotating motion causing serious or even fatal injury.

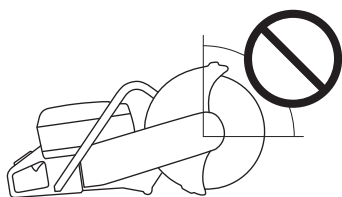

## Climbing kickback

If the kickback zone is used for cutting the reactive force drives the blade to climb up in the cut. Do not use the kickback zone. Use the lower quadrant of the blade to avoid climbing kickback.

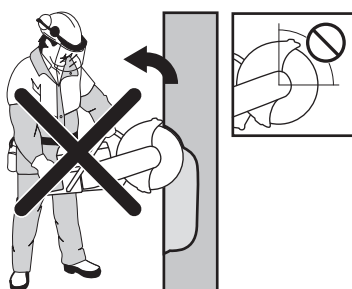

## Pinching kickback

Pinching is when the cut closes and pinches the blade. If the blade is pinched or stalled the reactive force will be strong and you might not be able to control the power cutter.

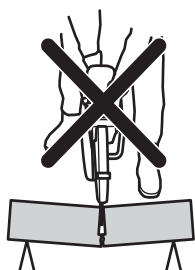

If the blade is pinched or stalled in the kickback zone, the reactive force will push the power cutter up and back towards the user in a rotating motion causing serious or even fatal injury.

## Pipe cutting and pinching

Special care should be taken when cutting in pipes. If the pipe is not properly supported and the cut kept open through out the cut the blade might be pinched in the kickback zone and cause a severe kickback.

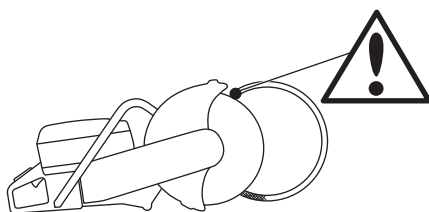

## How to avoid kickback

Avoiding kickback is simple.

- The work piece must always be supported so that the cut stays open when cutting through. When the cut opens there is no kickback. If the cut closes and pinches the blade there is always a risk of kickback.

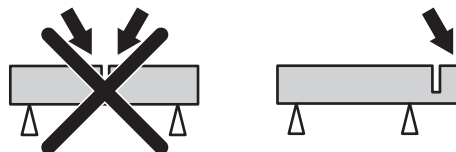

- Take care when inserting the blade in an existing cut.
- Be alert to movement of the work piece or anything else that can occur, which could cause the cut to close and pinch the blade.

## Transport and storage

- Secure the equipment during transportation in order to avoid transport damage and accidents.
- Do not store or transport the power cutter with the cutting blade fitted.
- For transport and storage of cutting blades, see the section "Cutting blades".
- For transport and storage of fuel, see the section "Fuel handling".
- Store the equipment in a lockable area so that it is out of reach of children and unauthorized persons.

# STARTING AND STOPPING

## Before starting



**WARNING!** Please read the operator's manual carefully and make sure you understand the instructions before using the machine.

Wear personal protective equipment. See instructions under the heading "Personal protective equipment".

Make sure no unauthorised persons are in the working area, otherwise there is a risk of serious personal injury.

Check that the fuel cap is properly secured, and that there is no fuel leakage. Risk of fire.

- Perform daily maintenance. See instructions in the section "Maintenance".

## Starting

- **Decompression valve:** Press in the valve to reduce the pressure in the cylinder, this is to assist starting the power cutter. The decompression valve should always be used when starting. The valve automatically returns to its initial position when the machine starts.

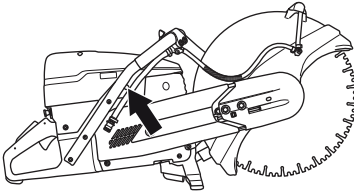

- **Stop switch:** Make sure that the stop switch (STOP) is in the left position.

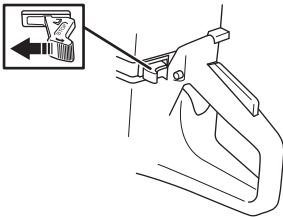

- **Choke - cold engine:** Pull the choke control fully out.

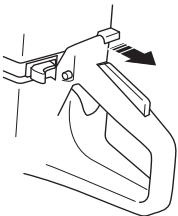

- **Start throttle position:** Press in the throttle trigger lock, throttle control and then the start throttle lock (A). Release the throttle control and it is locked in the half throttle position. The lock releases when the throttle control is pressed in fully.

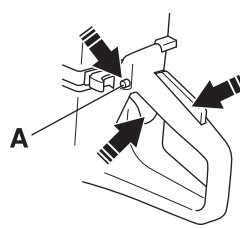

## Start the engine



**WARNING!** The cutting blade rotates when the engine is started. Make sure it can rotate freely.

- Grip the front handle with your left hand. Put your right foot on the lower section of the rear handle pressing the machine against the ground. **Never twist the starter cord around your hand.**



- Grip the starter handle, slowly pull out the cord with your right hand until you feel some resistance (the starter pawls grip), now quickly and powerfully pull the cord.

**NOTICE!** Do not pull the starter cord all the way out and do not let go of the starter handle when the cord is fully extended. This can damage the machine.

- **With a cold engine:** The machine stops when the engine fires because the choke control is pulled out. Press the choke control and the decompression valve. Pull the starter handle until the engine starts.
- When the engine starts, quickly apply full throttle to automatically disengage fast idle.

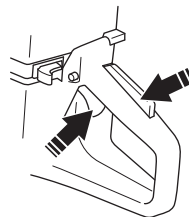

---

# STARTING AND STOPPING

---

## Stopping



**CAUTION!** The cutting blade continues to rotate up to a minute after the motor has stopped. (Blade coasting.) Make sure that the cutting blade can rotate freely until it is completely stopped. Carelessness can result in serious personal injury.

- Stop the engine by moving the stop switch (STOP) to the right.

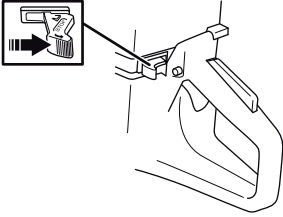

# MAINTENANCE

## General



**WARNING!** The user must only carry out the maintenance and service work described in this Operator's Manual. More extensive work must be carried out by an authorized service workshop.

The engine should be switched off, and the stop switch in STOP position.

Wear personal protective equipment. See instructions under the heading "Personal protective equipment".

The life span of the machine can be reduced and the risk of accidents can increase if machine maintenance is not carried out correctly and if service and/or repairs are not carried out professionally. If you need further information please contact your nearest service workshop.

- Let your Husqvarna dealer regularly check the machine and make essential adjustments and repairs.

## Maintenance schedule

In the maintenance schedule you can see which parts of your machine that require maintenance, and with which intervals it should take place. The intervals are calculated based on daily use of the machine, and may differ depending on the rate of usage.

Daily maintenance	Weekly maintenance	Monthly maintenance
<b>Cleaning</b>	<b>Cleaning</b>	<b>Cleaning</b>
External cleaning		Spark plug
Cooling air intake		Fuel tank
<b>Functional inspection</b>	<b>Functional inspection</b>	<b>Functional inspection</b>
General inspection	Vibration damping system*	Fuel system
Throttle lockout*	Muffler*	Air filter
Stop switch*	Drive belt	Drive gear, clutch
Blade guard*	Carburettor	
Cutting blade**	Starter	

\*See instructions in the section "Machine's safety equipment".

\*\* See instructions in the section "Cutting blades" and "Assembly and settings".

# MAINTENANCE

## Cleaning

### External cleaning

- Clean the machine daily by rinsing it with clean water after the work is finished.

### Cooling air intake

- Clean the cooling air intake when needed.

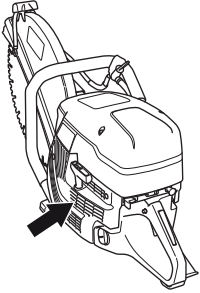

**NOTICE!** A dirty or blocked air intake results in the machine overheating which causes damage to the piston and cylinder.

### Spark plug

- If the machine is low on power, difficult to start or runs poorly at idle speed: always check the spark plug first before taking other steps.
- Ensure that the spark plug cap and ignition lead are undamaged to avoid the risk of electric shock.
- If the spark plug is dirty, clean it and at the same time check that the electrode gap is 0.5 mm. Replace if necessary.

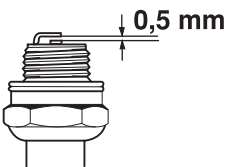

**NOTICE!** Always use the recommended spark plug type! Use of the wrong spark plug can damage the piston/cylinder.

These factors cause deposits on the spark plug electrodes, which may result in operating problems and starting difficulties.

- An incorrect fuel mixture (too much or incorrect type of oil).
- A dirty air filter.

## Functional inspection

### General inspection

- Check that nuts and screws are tight.

### Drive belt

#### Check the tension of the drive belt

- For correct tensioning of the drive belt, the square nut should be positioned opposite the marking on the belt cover.

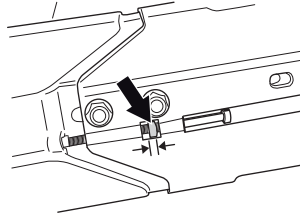

#### Tensioning the drive belt

- The tension of a new drive belt must be readjusted after one or two tanks of fuel have been used.
- The drive belt is enclosed and well protected from dust and dirt.
- When the drive belt is to be tensioned, release the bolts holding the cutting arm.

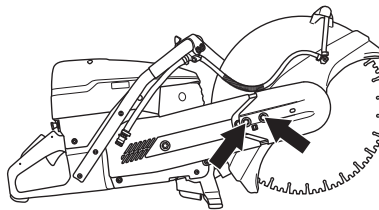

- Screw the adjuster screw so that the square headed nut comes opposite the marking on the cover. This automatically ensures that the belt has the correct tension.

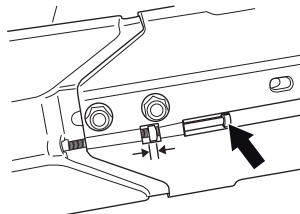

- Tighten both of the screws holding the cutting head using a T-wrench.

# MAINTENANCE

## Replacing the drive belt



**WARNING! Never start the engine when the belt pulley and clutch are removed for maintenance. Do not start the machine without the cutting arm or cutting head fitted. Otherwise the clutch could come loose and cause personal injuries.**

- First release the two bolts and then the adjuster screw to release the belt tension.

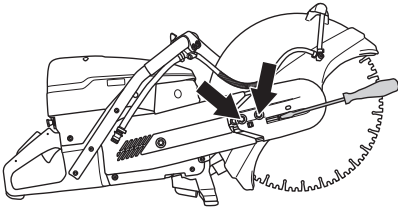

- Now unscrew the bolts and dismantle the belt guard.

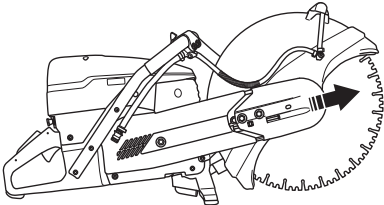

- Remove the belt from the belt pulley.

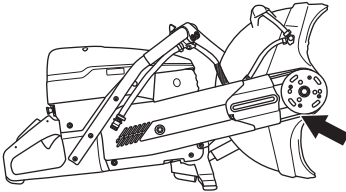

- The cutting head is now loose and can be removed from the machine.
- Remove the nut. Remove the side cover.

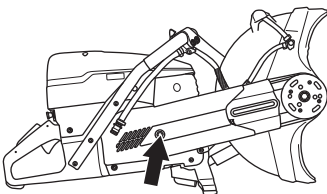

- Replace the drive belt.
- Assemble in the reverse order as set out for dismantling.

## Carburettor

### General

Your Husqvarna product has been designed and manufactured to specifications that reduce harmful emissions. After the engine has used 8-10 tanks of fuel the engine will be run-in. To ensure that it continues to run at peak performance and to minimise harmful exhaust emissions after the running-in period, ask your dealer/service workshop (who will have a rev counter at their disposal) to adjust your carburettor.

The carburettor governs the engine speed via the throttle. Air and fuel are mixed in the carburettor.

## High speed jet

The carburetor is equipped with fixed H-jet to ensure the engine always receives the correct fuel air mixture. If the engine lacks power or accelerates poorly do the following:

- Check the air filter and replace if necessary. When this does not help, contact an authorised service workshop.

## Adjusting low speed jet

Apply full throttle a couple of times and check that the saw is accelerating without hesitation. Basic setting L: 1 1/4 turn open. If an adjustment is necessary, try to reach the maximum idle speed, by slowly closing the low speed needle L clockwise until the engine starves from fuel. Then open (counter-clockwise) 1/8 of a turn. Check the engine acceleration.

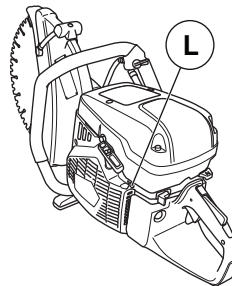

**NOTICE!** A too lean adjusted low speed needle (the L-needle closed too much) results in starting difficulties.

## Adjusting the idle speed



**CAUTION!** If the idle speed cannot be adjusted so that the cutting attachment stops, contact your dealer/service workshop. Do not use the machine until it has been correctly adjusted or repaired.

Start the engine and check the idling setting. When the carburettor is set correctly the cutting blade should be still while engine is idling.

- Adjust the idle speed using the T screw. When an adjustment is necessary, first turn the screw clockwise until the blade starts to rotate. Now turn the screw anti-clockwise until the blade stops rotating.

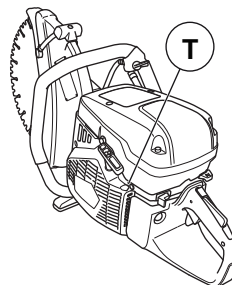

Rec. idle speed: 2700 rpm

# MAINTENANCE

## Starter

### Checking the starter cord

- Loosen the screws that hold the starter against the crankcase and remove the starter.

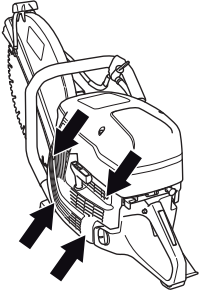

- Pull the cord out about 30 cm and lift it into the cut-out in the periphery of the starter pulley. When the cord is intact: Release the spring tension by letting the pulley rotate slowly backwards.

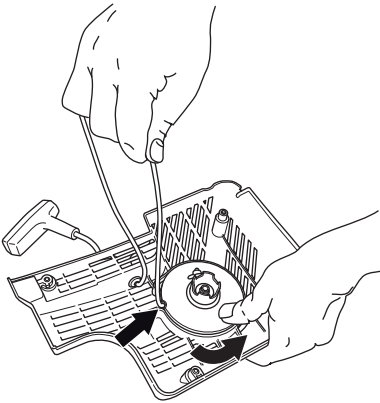

### Changing a broken or worn starter cord

- Remove any remnants of the old starter cord and check that the return spring works. Insert the new starter cord through the hole in the starter housing and in the cord pulley.

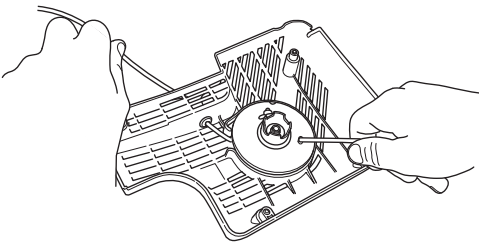

- Secure the starter cord around the cord pulley as illustrated. Tighten the fastening well and ensure that the free end is as short as possible. Secure the end of the starter cord in the starter handle.

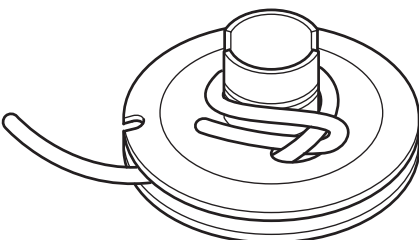

### Tensioning the recoil spring

- Guide the cord through the cut-out in the periphery of the pulley and wind the cord 3 times clockwise around the centre of the starter pulley.

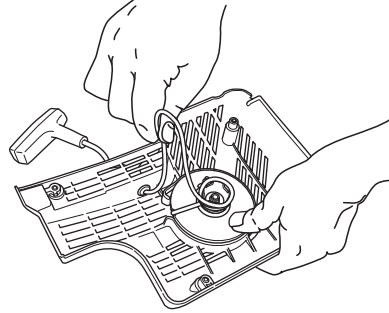

- Now pull the starter handle and in doing so tension the spring. Repeat the procedure once more, but this time with four turns.
- Note that the starter handle is drawn to its correct home position after tensioning the spring.
- Check that the spring is not drawn to its end position by pulling out the starter line fully. Slow the starter pulley with your thumb and check that you can turn the pulley at least a further half turn.

### Changing a broken recoil spring



**WARNING!** When the recoil spring is wound up in the starter housing it is under tension and can, if handled carelessly, pop out and cause personal injury.

Always be careful when changing the recoil spring or the starter cord. Always wear protective goggles.

- Undo the bolt in the centre of the pulley and remove the pulley.

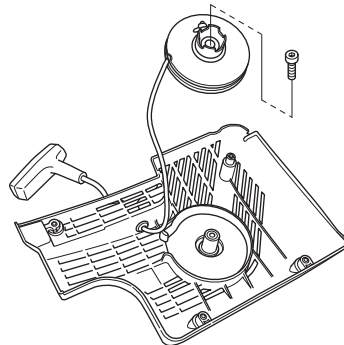

- Carefully lift the cover that protects the spring. Bear in mind that the return spring lies tensioned in the starter housing.
- Carefully remove the spring using pliers.

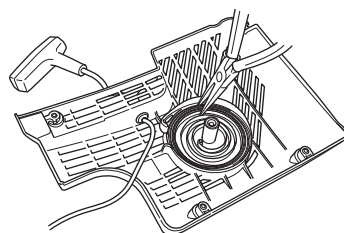

- Lubricate the recoil spring with light oil. Fit the pulley and tension the recoil spring.



# MAINTENANCE

## Fitting the starter

- To fit the starter, first pull out the starter cord and place the starter in position against the crankcase. Then slowly release the starter cord so that the pulley engages with the pawls.

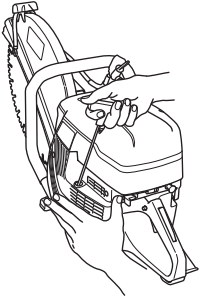

- Tighten the screws.

## Fuel system

### General

- Check that the fuel cap and its seal are not damaged.
- Check the fuel hose. Replace when damaged.

### Fuel filter

- The fuel filter sits inside the fuel tank.
- The fuel tank must be protected from contamination when filling. This reduces the risk of operating disturbances caused by blockage of the fuel filter located inside the tank.
- The filter cannot be cleaned but must be replaced with a new filter when it is clogged. **The filter should be changed at least once per year.**

## Air filter

The air filter only needs to be checked if the engine drops in power.

- Loosen the screws. Remove the air filter cover.

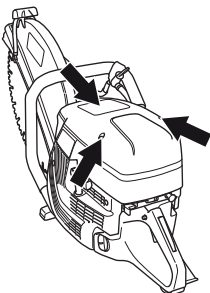

- Check the air filter and replace if necessary.

## Replacing the air filter

**NOTICE!** The air filter must not be cleaned or blown clean with compressed air. This will damage the filter.

- Loosen the screw.

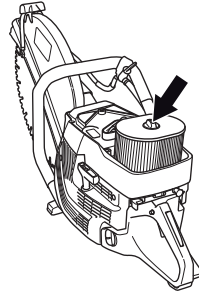

- Replace the air filter.

## Drive gear, clutch

- Check the clutch centre, drive gear and clutch spring for wear.

# TECHNICAL DATA

## Technical data

Engine	K 1260	K 1260 Rail
Cylinder displacement, cm <sup>3</sup>	119	119
Cylinder bore, mm	60	60
Stroke, mm	42	42
Idle speed, rpm	2700	2700
Max. fast idle speed, rpm	9300 (+/- 150)	9300 (+/- 150)
Power, kW/ rpm	5,8/9000	5,8/9000
<b>Ignition system</b>		
Manufacturer of ignition system	SEM	SEM
Type of ignition system	CD	CD
Spark plug	Champion RCJ 6Y/ NGK BPMR 7A	Champion RCJ 6Y/ NGK BPMR 7A
Electrode gap, mm	0,5	0,5
<b>Fuel and lubrication system</b>		
Manufacturer of carburettor	Walbro	Walbro
Carburettor type	WG 9A	WG 9A
Fuel tank capacity, litre	1,25	1,25
<b>Weight</b>		
Power cutter without fuel and cutting blade, kg		
14" (350 mm)	13,7	15,0
16" (400 mm)	14,4	15,6
Rail fixture, kg		
RA 10		5,5
RA 10 S		5,7
<b>Noise emissions (see note 1)</b>		
Sound power level, measured dB(A)	116	116
Sound power level, guaranteed L <sub>WA</sub> dB(A)	117	117
<b>Sound levels (see note 2)</b>		
Equivalent sound pressure level at the operator's ear, dB(A)	103	103
<b>Equivalent vibration levels, a<sub>hveq</sub> (see note 3)</b>		
	<b>14" / 16"</b>	<b>14" / 16"</b>
Front handle, m/s <sup>2</sup>	3,3/3,6	5/5
Rear handle, m/s <sup>2</sup>	3,5/4,1	4,1/3,6

Note 1: Noise emissions in the environment measured as sound power (L<sub>WA</sub>) in conformity with EC directive 2000/14/EC. The difference between guaranteed and measured sound power is that the guaranteed sound power also includes dispersion in the measurement result and the variations between different machines of the same model according to Directive 2000/14/EC.

Note 2: Equivalent sound pressure level, according to EN ISO 19432, is calculated as the time-weighted energy total for different sound pressure levels under various working conditions. Reported data for equivalent sound pressure level for the machine has a typical statistical dispersion (standard deviation) of 1 dB (A).

Note 3: Equivalent vibration level, according to EN ISO 19432, is calculated as the time-weighted energy total for vibration levels under various working conditions. Reported data for equivalent vibration level has a typical statistical dispersion (standard deviation) of 1 m/s<sup>2</sup>. The measurements for K 1260 Rail were carried out with RA 10 fitted to the rail.

## Cutting equipment

Cutting blade	Max. peripheral speed, m/s	Max. speed of output shaft, rpm
14" (350 mm)	100	5400
16" (400 mm)	100	4700

---

# TECHNICAL DATA

---

## EC-declaration of conformity

### (Applies to Europe only)

**Husqvarna AB**, SE-561 82 Huskvarna, Sweden, tel +46-36-146500, declares under sole responsibility that the power cutters **Husqvarna K 1260, K 1260 Rail** from 2010's serial numbers and onwards (the year is clearly stated in plain text on the rating plate with subsequent serial number), complies with the requirements of the COUNCIL'S DIRECTIVES:

- of May 17, 2006 "relating to machinery" **2006/42/EC**
- of December 15, 2004 "relating to electromagnetic compatibility" **2004/108/EC**.
- of May 8, 2000 "relating to the noise emissions in the environment" **2000/14/EC**.

For information relating to noise emissions, see the chapter Technical data.

The following standards have been applied: **EN ISO 12100:2010, CISPR 12:2007, EN ISO 19432:2008**.

Notified body: 0404, SMP Svensk Maskinprovning AB, Fyrisborgsgatan 3, SE-754 50 Uppsala, Sweden, has performed voluntary type examination in accordance with the machinery directive (2006/42/EC) on behalf of Husqvarna AB. The certificate has the number: SEC/10/2287

In addition, SMP, Svensk Maskinprovning AB, Fyrisborgsgatan 3, SE-754 50 Uppsala, Sweden, has certified conformity with annex V of the Council's Directive of May 8, 2000 "relating to the noise emissions in the environment" 2000/14/EC. The certificate has the number: 01/169/030 - K 1260, K 1260 Rail

Gothenburg February 2, 2011

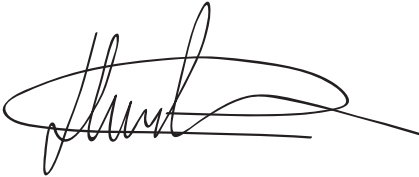

Henric Andersson

Vice President, Head of Power Cutters and Construction Equipment

Husqvarna AB

(Authorized representative for Husqvarna AB and responsible for technical documentation.)

**Original instructions**

**1154276-26**



**2011-05-24**