

# **Operator's manual    操作手册**

## **DM 230**

Please read the operator's manual carefully and make sure you understand the instructions before using the machine.

在使用前请仔细阅读说明，并在充分了解动力切割机后才可开始使用。



**EN, CN**

# KEY TO SYMBOLS

## Symbols on the machine:

**WARNING!** The machine can be a dangerous tool if used incorrectly or carelessly, which can cause serious or fatal injury to the operator or others.



Please read the operator's manual carefully and make sure you understand the instructions before using the machine.



Always wear:

- Approved protective helmet
- Approved hearing protection
- Protective goggles or a visor
- Breathing mask



This product is in accordance with applicable EC directives.



**Environmental marking.** Symbols on the product or its packaging indicate that this product cannot be handled as domestic waste. It must instead be submitted to an appropriate recycling station for the recovery of electrical and electronic equipment.



By ensuring that this product is taken care of correctly, you can help to counteract the potential negative impact on the environment and people that can otherwise result through the incorrect waste management of this product.

For more detailed information about recycling this product, contact your municipality, your domestic waste service or the shop from where you purchased the product.

Ensure that water cannot leak into the machine when drilling in the ceiling. Use an appropriate water collector and cover the machine in plastic, but do not cover the air intakes and air outlets.



**Other symbols/decals on the machine refer to special certification requirements for certain markets.**

## Symbols in the operator's manual:

Inspection and/or maintenance should be carried out with the motor switched off and the plug disconnected.

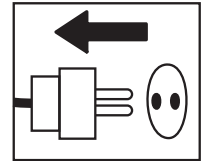

Always wear approved protective gloves.

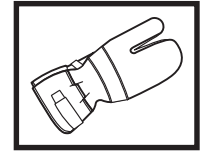

Regular cleaning is required.

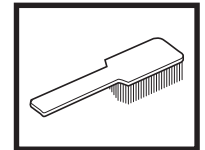

Visual check.

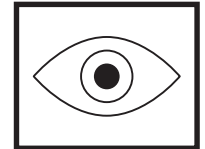

Protective goggles or a visor must be worn.



---

# CONTENTS

---

## Contents

### KEY TO SYMBOLS

Symbols on the machine: ..... 2

Symbols in the operator's manual: ..... 2

### CONTENTS

Contents ..... 3

### WHAT IS WHAT?

What is what on the drilling machine? ..... 4

### SAFETY INSTRUCTIONS

Steps before using a new drilling machine ..... 5

Personal protective equipment ..... 5

### SAFETY INSTRUCTIONS

General safety warnings ..... 6

General working instructions ..... 7

Machine's safety equipment ..... 8

Checking, maintaining and servicing the machine's  
safety equipment ..... 9

### PRESENTATION

DM 230 ..... 10

### STARTING AND STOPPING

Before starting ..... 11

Starting ..... 11

Stopping ..... 11

### MAINTENANCE

General ..... 12

Changing the drill bit ..... 12

Cleaning ..... 12

Water tap ..... 12

Electrical Feed ..... 12

Repairs ..... 12

Changing the gearbox oil ..... 12

Replacing the carbon brushes ..... 13

Daily maintenance ..... 13

### TECHNICAL DATA

EC-declaration of conformity ..... 15

WIRING DIAGRAM ..... 29

# WHAT IS WHAT?

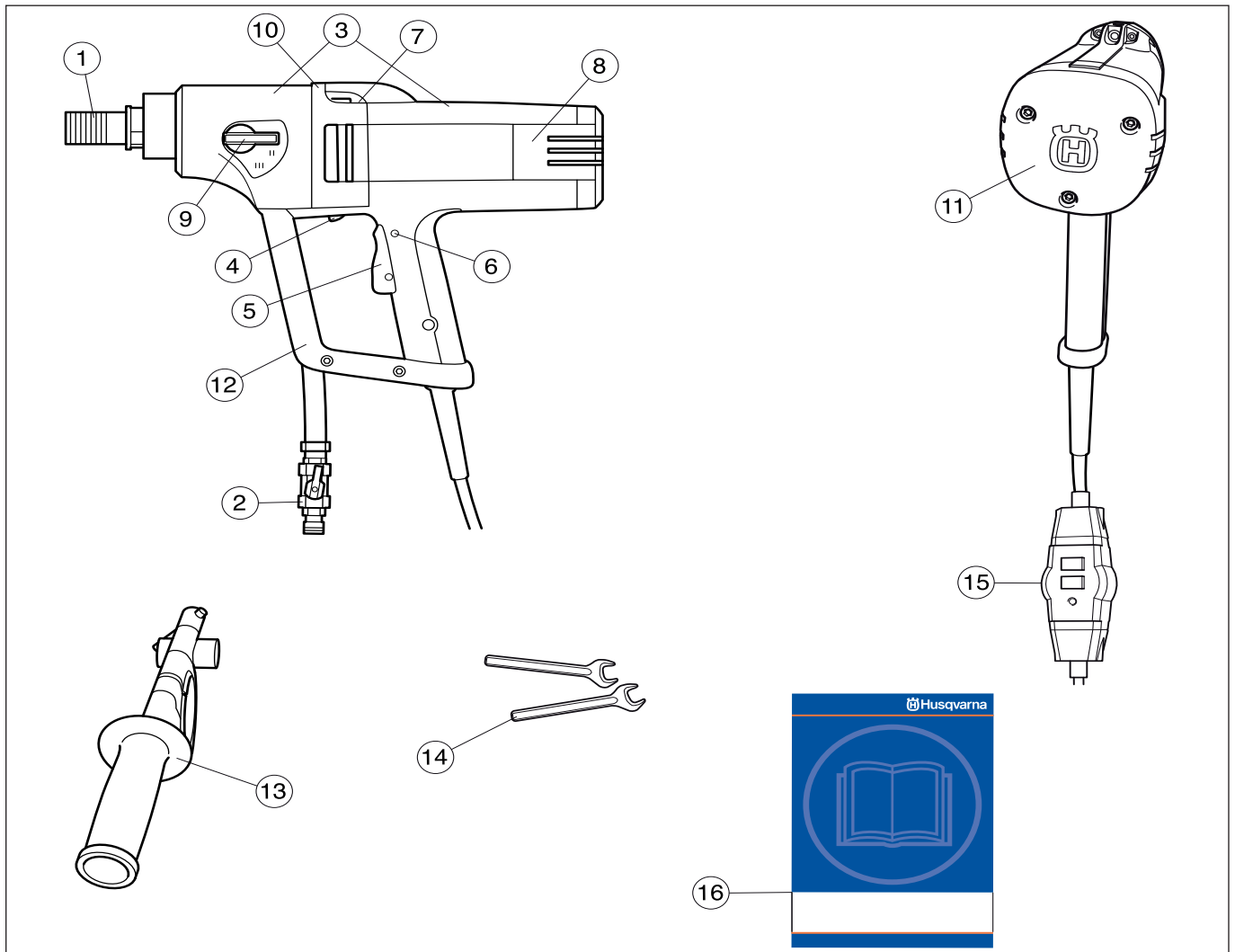

## What is what on the drilling machine?

- |                            |   |
|----------------------------|---|
| 1 Drill spindle            | 9 Gear knob   |
| 2 Water connector          | 10 Leakage hole (if water or oil trickles out from the leakage hole contact your dealer to replace the seals) |
| 3 Gearbox and motor module | 11 Stiffener  |
| 4 Smart Start®             | 12 Protecting brace and carrying handle   |
| 5 Power switch             | 13 Handle and adapter   |
| 6 Power switch lock        | 14 Spanners   |
| 7 Spirit level             | 15 Ground fault circuit interrupter   |
| 8 Inspection cover         | 16 Operator's manual  |

# SAFETY INSTRUCTIONS

## Steps before using a new drilling machine

- Do not use the drilling machine without first reading and understanding the contents of this Operator's Manual.
- This machine is designed for and intended for drilling concrete, brick and different stone materials. All other use is improper.
- The machine is intended for use in industrial applications by experienced operators.

## Always use common sense

It is not possible to cover every conceivable situation you can face when using a drilling machine. Always exercise care and use your common sense. Avoid all situations which you consider to be beyond your capability. If you still feel uncertain about operating procedures after reading these instructions, you should consult an expert before continuing. Do not hesitate to contact your dealer or us if you have any more questions about the use of the drilling machine. We will willingly be of service and provide you with advice as well as help you to use your drilling machine both efficiently and safely.

Do not hesitate to contact your dealer if you have any more questions about the use of the machine. We will willingly be of service and provide you with advice as well as help you to use your machine both efficiently and safely.

Let your Husqvarna dealer check the drilling machine regularly and make essential adjustments and repairs.

Husqvarna Construction Products has a policy of continuous product development. Husqvarna reserves the right to modify the design and appearance of products without prior notice and without further obligation introduce design modifications.

All information and all data in the Operator's Manual were applicable at the time the Operator's Manual was sent to print.



**WARNING! Under no circumstances should you modify the original design of the machine without approval from the manufacturer. Always use original spare parts. Unauthorized modifications and/or accessories may lead to serious injury or death to the user or others.**



**WARNING! The use of products such as cutters, grinders, drills, that sand or form material can generate dust and vapours which may contain hazardous chemicals. Check the nature of the material you intend to process and use an appropriate breathing mask.**

## Personal protective equipment



**WARNING! You must use approved personal protective equipment whenever you use the machine. Personal protective equipment cannot eliminate the risk of injury but it will reduce the degree of injury if an accident does happen. Ask your dealer for help in choosing the right equipment.**

- Protective helmet
- Hearing protection
- Protective goggles or a visor

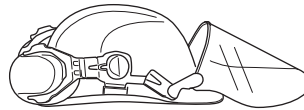

- Breathing mask

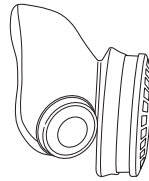

- Heavy-duty, firm grip gloves.

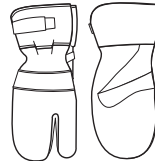

- Tight-fitting, heavy-duty and comfortable clothing that permits full freedom of movement.



- Boots with steel toe-caps and non-slip sole.



- Always have a first aid kit nearby.



# SAFETY INSTRUCTIONS

## General safety warnings



**WARNING! Read all safety warnings and all instructions. Failure to follow the warnings and instructions may result in electric shock, fire and/or serious injury.**

Save all warnings and instructions for future reference.

The term "power tool" in the warnings refers to your mains-operated (corded) power tool or battery-operated (cordless) power tool.

## Work area safety

- Keep work area clean and well lit. Cluttered or dark areas invite accidents.
- Do not operate power tools in explosive atmospheres, such as in the presence of flammable liquids, gases or dust. Power tools create sparks which may ignite the dust or fumes.
- Keep children and bystanders away while operating a power tool. Distractions can cause you to lose control.
- Do not use the machine in bad weather, such as dense fog, rain, strong wind, intense cold, etc. Working in bad weather is tiring and can lead to dangerous conditions, e.g. slippery surfaces.
- Ensure when cutting that no material can become loose and fall, causing operating injury. Take great care when working on sloping ground.
- Always check the rear side of the surface where the drill bit will emerge when drilling right through. Secure and cordon off the area and make sure that no one can be injured or material damaged.

## Electrical safety

- Power tool plugs must match the outlet. Never modify the plug in any way. Do not use any adapter plugs with earthed (grounded) power tools. Unmodified plugs and matching outlets will reduce the risk of electric shock.
- Avoid body contact with earthed or grounded surfaces, such as pipes, radiators, ranges and refrigerators. There is an increased risk of electric shock if your body is earthed or grounded.
- Do not expose power tools to rain or wet conditions. Water entering a power tool will increase the risk of electric shock.
- Do not abuse the cord. Never use the cord for carrying, pulling or unplugging the power tool. Keep cord away from heat, oil, sharp edges or moving parts. Damaged or entangled cords increase the risk of electric shock.
- When operating a power tool outdoors, use an extension cord suitable for outdoor use. Use of cord suitable for outdoor use reduces the risk of electric shock.
- Check that the cord and extension cord are intact and in good condition. Never use the machine if the cord is damaged, hand it in to an authorized service workshop for repair.

- If operating a power tool in a damp location is unavoidable, use a ground fault circuit interrupter protected supply. Use of an GFCI reduces the risk of electric shock.
- To avoid overheating do not use the extension cord while it is rolled up.
- The machine should be connected to an earthed outlet socket. Check that the mains voltage corresponds with that stated on the rating plate on the machine.
- Ensure the cord is behind you when you start to use the machine so that the cord will not be damaged.



**WARNING! Do not wash the machine with water, as water can enter the electrical system or the engine and cause damage to the machine or short circuit.**

## Personal safety

- Stay alert, watch what you are doing and use common sense when operating a power tool. Do not use a power tool while you are tired or under the influence of drugs, alcohol or medication. A moment of inattention while operating power tools may result in serious personal injury.
- Use personal protective equipment. Always wear eye protection. Protective equipment such as dust mask, non-skid safety shoes, hard hat, or hearing protection used for appropriate conditions will reduce personal injuries.
- Prevent unintentional starting. Ensure the switch is in the OFF-position before connecting to power source and/or battery pack, picking up or carrying the tool. Carrying power tools with your finger on the switch or energising power tools that have the switch on invites accidents.
- Remove any adjusting key or wrench before turning the power tool on. A wrench or a key left attached to a rotating part of the power tool may result in personal injury.
- Do not overreach. Keep proper footing and balance at all times. This enables better control of the power tool in unexpected situations.
- Dress properly. Do not wear loose clothing or jewellery. Keep your hair, clothing and gloves away from moving parts. Loose clothes, jewellery or long hair can be caught in moving parts.
- If devices are provided for the connection of dust extraction and collection facilities, ensure that these are connected and properly used. Use of dust collection can reduce dust-related hazards.
- Make sure that no pipes or electrical cables are routed in the area to be drilled.
- Ensure the cord is behind you when you start to use the machine so that the cord will not be damaged.
- Never leave the machine unsupervised with the motor running. A rotating drill bit can entail a risk of serious injury.
- Remain at a distance from the drill bit when the motor is running.
- Always unplug the machine during longer work breaks.

# SAFETY INSTRUCTIONS

- Never work alone, always ensure there is another person close at hand. Apart from being able to receive help to assemble the machine, you can also get help if an accident should occur.



**WARNING!** Use auxiliary handles supplied with the tool. Loss of control can cause personal injury.



**WARNING!** Overexposure to vibration can lead to circulatory damage or nerve damage in people who have impaired circulation. Contact your doctor if you experience symptoms of overexposure to vibration. These symptoms include numbness, loss of feeling, tingling, pricking, pain, loss of strength, changes in skin colour or condition. These symptoms normally appear in the fingers, hands or wrists.



**CAUTION!** Wear ear protectors with impact drills. Exposure to noise can cause hearing loss.

## Power tool use and care

- Do not force the power tool. Use the correct power tool for your application. The correct power tool will do the job better and safer at the rate for which it was designed.
- Do not use the power tool if the switch does not turn it on and off. Any power tool that cannot be controlled with the switch is dangerous and must be repaired.
- Disconnect the plug from the power source and/or the battery pack from the power tool before making any adjustments, changing accessories, or storing power tools. Such preventive safety measures reduce the risk of starting the power tool accidentally.
- Store idle power tools out of the reach of children and do not allow persons unfamiliar with the power tool or these instructions to operate the power tool. Power tools are dangerous in the hands of untrained users.
- Maintain power tools. Check for misalignment or binding of moving parts, breakage of parts and any other condition that may affect the power tool's operation. If damaged, have the power tool repaired before use. Many accidents are caused by poorly maintained power tools.
- Keep cutting tools sharp and clean. Properly maintained cutting tools with sharp cutting edges are less likely to bind and are easier to control.
- Use the power tool, accessories and tool bits etc. in accordance with these instructions, taking into account the working conditions and the work to be performed. Use of the power tool for operations different from those intended could result in hazardous situations.
- Never use a machine that has been modified in any way from its original specification.
- Do not store or transport the drilling machine with the drill bit fitted in order to protect your drilling machine and drill bits from damage.

- Do not overload the machine. Overloading can damage the machine.
- Keep all parts in good working order and ensure that all fixtures are properly tightened.

## Service

- Have your power tool serviced by a qualified repair person using only identical replacement parts. This will ensure that the safety of the power tool is maintained.

## General working instructions



**WARNING!** This section takes up the basic safety precautions for working with the drilling machine. This information is never a substitute for professional skills and experience. If you encounter a situation where you are uncertain how to proceed you should ask an expert. Contact your dealer, service agent or an experienced drilling machine user. Do not attempt any task that you feel unsure of!

- The machine has a very high torque. This demands good concentration during work, as serious personal injuries can occur if the drill bit suddenly jams.
- Keep your hands at a safe distance from the drill spindle and drill bit when the machine is running.
- Keep an eye open for oil or water leakage. If water or oil trickles out from the leakage hole on the top of the pinion neck, the seals must be replaced.

## Handheld drilling



**WARNING!** Do not perform handheld drilling in first gear as the machine has a powerful torque that can result in personal injuries should the drill bit jam.

- Always use a drill bit with a max. diameter of 75 mm with handheld drilling. The larger the drill bit the greater the reaction if the drill jams.
- Always make sure you are standing firmly when carrying out handheld drilling.

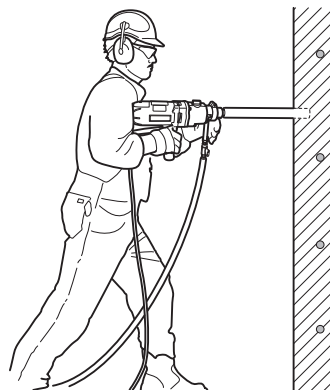

# SAFETY INSTRUCTIONS

## Stand drilling

- Always use a drilling stand if drilling is to be performed from a ladder or scaffold.

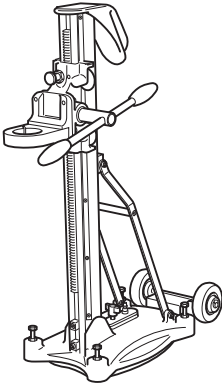

Handheld drilling in these situations is full of risks, as the risk of falling is very high if the drill bit jams.



- Make sure that the stand is secured correctly.
- Make sure that the drilling machine is secured correctly in the stand.

## Drilling outdoors

- Always use extension cables that are approved for outdoor use.

## Drilling in ceilings and the like

- Use a water collector to avoid water penetrating into the machine. The machine must be covered with plastic or the like in order to prevent water penetrating into the machine, but do not cover the air intakes and air outlets.

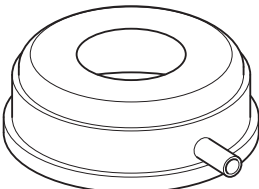

**IMPORTANT!** The air intake must not be covered.

## Machine's safety equipment

This section describes the machine's safety equipment, its purpose, and how checks and maintenance should be carried out to ensure that it operates correctly. See the "What is what?" section to locate where this equipment is positioned on your machine.



**WARNING!** Never use a machine that has faulty safety equipment! Safety equipment must be inspected and maintained. See instructions under the heading **Checking, maintaining and servicing the machine's safety equipment**. If your machine does not pass all the checks, take it to a service workshop for repair.

## Power switch

The power switch should be used to start and stop the machine.

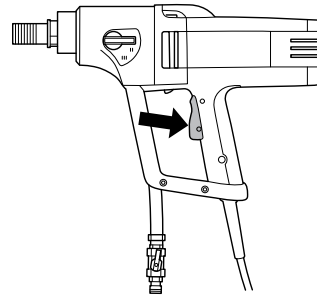

## Power switch lock

The power switch lock is designed to prevent accidental operation of the switch. When the lock (A) is pressed in the power switch (B) is released.

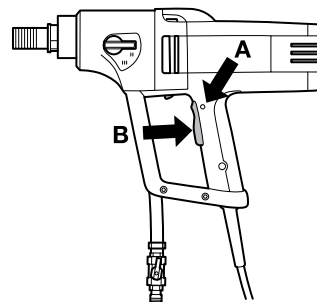

The power switch lock remains depressed as long as the power switch is depressed. When the grip on the handle is released both the power switch and power switch lock are reset. This movement is controlled by two independent return springs. This position results in the machine stopping and the power switch being locked.



# SAFETY INSTRUCTIONS

## Ground fault circuit interrupter

Ground fault circuit interrupters are for protection in case an electrical fault should occur.

The LED indicates that the ground fault circuit interrupter is on and that the machine can be switched on. If the LED is not on, push the RESET button (green).



## Checking, maintaining and servicing the machine's safety equipment



**IMPORTANT!** All servicing and repair work on the machine requires special training. This is especially true of the machine's safety equipment. If your machine fails any of the checks described below you must contact your service agent. When you buy any of our products we guarantee the availability of professional repairs and service. If the retailer who sells your machine is not a servicing dealer, ask him for the address of your nearest service agent.

## Checking the power switch

Start the machine, release the power switch and check that the motor and the drill bit stop.

A defective power switch should be replaced by an authorized service workshop.

## Checking the power switch lock

Press the power switch and check that the power switch is locked when the power switch lock is pressed in.

Press in the power switch and make sure the switch returns to its original position when you release it.

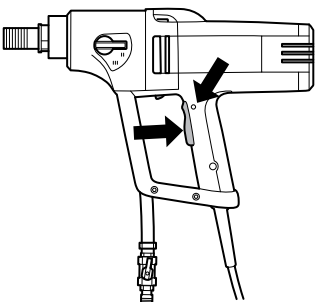

Check that the power switch and the power switch lock move easily.

## Check the ground fault circuit interrupter

Connect the machine to the socket. Push the RESET button (green) and the red LED lights up.



Push the TEST button (blue).

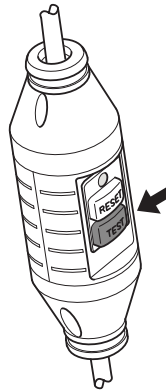

The ground fault circuit interrupter should trip and the machine switch off instantly. If not, contact your dealer.

Reset with the RESET button (green).

# PRESENTATION

## DM 230

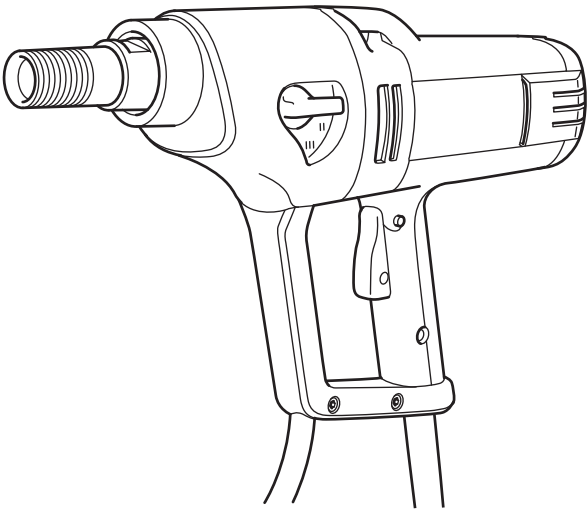

It is our wish that you will be satisfied with your product and that it will be your companion for a long time. Think of this operator's manual as a valuable document. By following its' content (using, service, maintenance etc) the life span and the second-hand value of the machine can be extended. If you will sell this machine, make sure that the buyer will get the operator's manual.

A purchase of one of our products gives you access to professional help with repairs and services. If the retailer who sells your machine is not one of our authorised dealers, ask him for the address of your nearest service workshop.

Husqvarna Construction Products has a policy of continuous product development. Husqvarna reserves the right to modify the design and appearance of products without prior notice and without further obligation introduce design modifications.

- The DM 230 is an electric handheld drill, intended for drilling concrete, brick and various stone materials.
- The drilling machine has a modular design and is easy to assemble.
- The machine is equipped with spirit levels to facilitate drilling and a swivel handle with an integrated adapter for support pins to make the work more comfortable.
- DM 230 has three speed ranges for drill bit sizes up to 150 mm.
- The machine has a water cooled gearbox with a pipe that runs through the spindle.
- DM 230 can also be connected to a vacuum cleaner with the help of an adapter, used for dry drilling, which is attached to the spindle.
- The drilling machine is equipped with Softstart™, Smartstart™, Elgard™ and speed control.

### Softstart™

Softstart™ is an electronic power limitation, making it easier to start the drill. Maximum speed is reached in about three seconds after the power switch is pressed in.

### Smartstart™

If the Smartstart™ button is pressed in directly after the power switch is pressed in, the speed is reduced by 50%. In Smartstart™ mode the machine has less power until the button is pressed in again. These functions are of great use for creating a pilot hole for drilling.

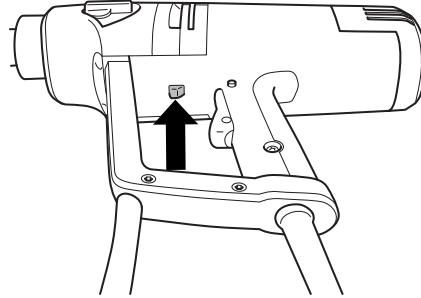

### Elgard™

Elgard™ is an electronic overload protection.

If the motor is overloaded, the overload protection pulses the motor. Reduce the load and the motor returns to its normal speed. The overload protection disconnects the power, if the machine is subjected to heavy loads or if the drill bit jams. The machine is reset by first releasing the power switch and then pressing it in again. If the drill bit jams, the mechanical slip clutch protects the gearbox before the overload protection disconnects the power.

### Speed control

Speed control always gives maximum output power from the machine. The speed control function provides the machine with a limited idling speed.

### Ergonomics

The soft rear section on the DM 230 has a large contact area so that the machine sits better against the body. The rounded handle makes the machine comfortable to hold while drilling. The protective loop forms a practical carry handle when transporting.

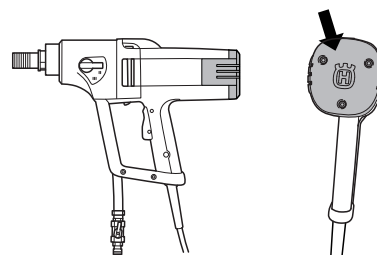

# STARTING AND STOPPING

## Before starting



**WARNING! Note the following before starting:**

The machine should be connected to an earthed outlet socket.

Check that the mains voltage corresponds with that stated on the rating plate on the machine.

Ensure you stand firmly. Keep people and animals well away from the working area.

Make sure that:

- The switch is undamaged. If not, the switch must be replaced by an authorised repairman.
- The switch is not sticking.
- The machine and its equipment are correctly installed:
  - The drill is secured properly.
  - If a stand is used, it must be attached to the machine by the fastening neck on the gearbox.
- Wear personal protective equipment. See instructions under the heading "Personal protective equipment".
- The water cooling or vacuum cleaner (with the help of adapter) are attached to the machine. Use suitable drill bits depending on whether water or dry drilling is being performed. In the event of uncertainty contact your dealer, your service workshop or an experienced operator.

## Starting

**IMPORTANT!** Changing gear may only be done when the machine is switched off. Otherwise there is a risk of damaging the gearbox.

- 1 Set the working speed by turning the drill spindle and at the same time move the gear knob to the required position.

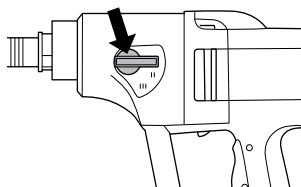

- 2 Turn on the water cooling (wet drilling) or switch on the vacuum cleaner (dry drilling).

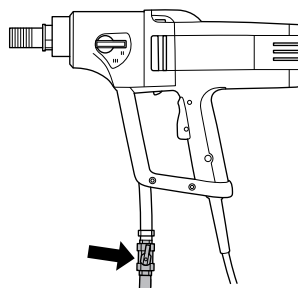

- 3 Hold the machine steady.
- 4 Press in the switch fully. Also press, if desired, the Smartstart™ button.

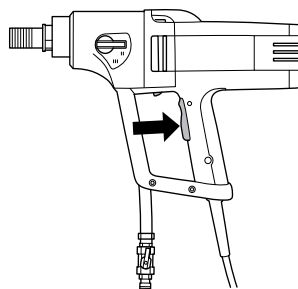

## Stopping



**WARNING! The drill bit continues to rotate for a while after the motor has been switched off. Do not stop the drill bit with your hands. Personal injuries can occur.**

Stop the motor by releasing the power switch.

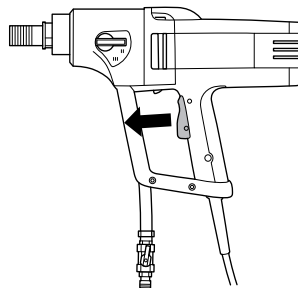

## Cooling

Run the machine unloaded for a minute or two to cool the motor.

# MAINTENANCE

## General



**WARNING! Inspection and/or maintenance should be carried out with the motor switched off and the plug disconnected.**

The lifetime of your machine can be extended considerably if it is used, cared for and maintained in the proper manner.

## Changing the drill bit



- 1 Pull out the plug.
- 2 Get:
  - The new drill bit.
  - The supplied open-ended spanners, size 24 mm and 32 mm.
  - Water-resistant grease.
- 3 Remove the old drill bit using the open-ended spanners.
- 4 Apply water-resistant grease to the thread of the new drill bit.
- 5 Attach the drill bit using the open-ended spanners.

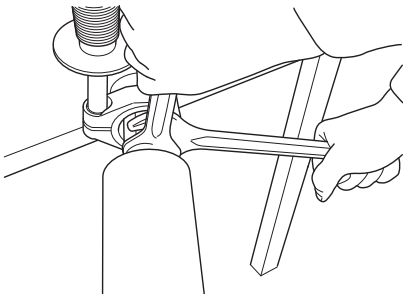

Before the machine is started, carefully check that the new bit is firmly attached.

## Cleaning



- Keep the machine and drill bit clean in order for drilling to be carried out safely.

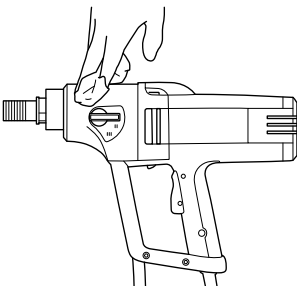

- Keep the handle dry and free of grease and oil.

- In order for the machine to always be cooled sufficiently the cooling air openings must be kept clear and clean. Blow down the machine regularly with compressed air.

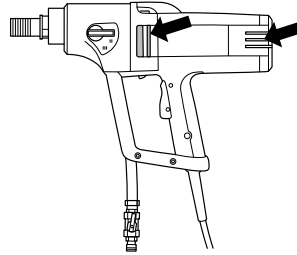

- Use compressed air to periodically clean the motor. Remove the inspection cover and clean the cover.

## Water tap

Check that the water tap functions. Do not use hoses that are distorted, worn or damaged.

## Electrical Feed



**WARNING! Never use damaged cables. They can cause serious, even fatal, personal injuries.**

Check that the cord and extension cord are intact and in good condition. Never use the machine if the cord is damaged, hand it in to an authorized service workshop for repair.

## Repairs

**Important** All types of repairs may only be carried out by authorised repairmen. This is so that the operators are not exposed to great risks.

## Changing the gearbox oil



Contact your dealer to get the right oil.

The oil in the gearbox must be changed after every 400 hours of operation. Do as follows:

- 1 Get:
  - New oil, Mobile Lube1 SHC 75W90 or other similar transmission oil.
  - A container for the old oil.
- 2 Secure the machine with drill spindle downwards in a vice or the like.

# MAINTENANCE

- 3 Unscrew the six screws holding the motor - gearbox modules together.

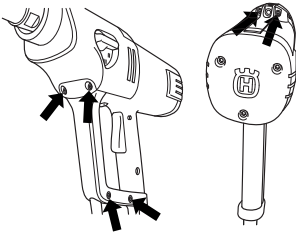

- 4 Carefully disassemble the machine.
- 5 Empty the gearbox oil into the container.
- 6 If necessary contact your dealer to clean the gearbox.
- 7 Pour the new oil into the gearbox, about 0.25 litres.

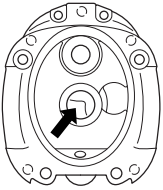

- 8 Fit a new O-ring between the motor cover and the gearbox cover. Contact your dealer to receive the correct O-ring.

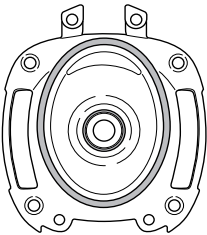

- 9 Reassemble the machine and screw in the six screws.

## Replacing the carbon brushes



The carbon brushes must be removed and checked regularly. Weekly if the machine is used daily or at longer intervals if the machine is used more seldom. The area of wear should be even and undamaged.

Both carbon brushes must always be replaced as a pair, but one at a time. Do as follows:

- 1 Remove the inspection cover's screws, 3.

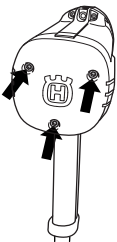

- 1 Lift the carbon brush holder spring to one side.
- 2 Loosen the screw.
- 3 Pull out the carbon brush connector.

- 4 Pull the carbon brush out from the holder.

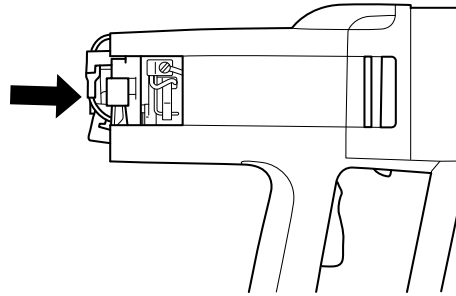

- 5 Clean the brush holder with compressed air or a brush. Replace the brush if worn.
- 6 Fit the new carbon brushes and, at the same time, check that they slide easily in the brush retainers.
- 7 Put the brush holder spring back into place.
- 8 Insert the carbon brush connection under the screw.
- 9 Repeat the procedure with the other carbon brush.
- 10 Refit the inspection cover screws, 3. Press together the rear section to make it easier to secure the screws. Make sure that the inspection cover enters its slots.

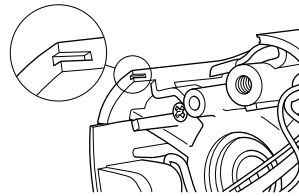

- 11 Let the machine idle for 10 minutes to run in the new carbon brushes.

## Daily maintenance



- 1 Check that nuts and screws are tight.
- 2 Check that the power switch unit works smoothly.
- 3 Check the ground fault circuit interrupter.
- 4 Clean the outside of the machine.
- 5 Check and clean the cooling air openings.
- 6 Check that the cord and extension cord are intact and in good condition.

# TECHNICAL DATA

## DM 230

Electric motor	Single-phase
Rated voltage, V	220-240/100-120
Rated output, W	1850

### Rated current, A

220-240 V	8 A
100-120 V	15 A

Weight, kg	7
------------	---

### Diameter drill bit, mm

Max. diameter of the drill bit, with stand	150 mm (5,9")
Max. diameter for the drill bit, handheld	75 mm (3")

Spindle thread	G 1/2"	G 1 1/4"
Water connector	G 1/4"	
Water pressure - max, bar	8	

Stand, mm	Ø 60 mm
-----------	---------

### Noise emissions (see note 1)

Sound power level, measured dB(A)	107
Sound power level, guaranteed dB(A)	108

### Sound levels (see note 2)

Sound pressure level at the operators ear, dB(A)	93
--	----

### Vibration levels, $a_{HV}$ (see note 3)

Front handle, $m/s^2$	2,8
Rear handle, $m/s^2$	2,6

Note 1: Noise emissions in the environment measured as sound power ( $L_{WA}$ ) in conformity with EN 12348.

Note 2: Noise pressure level according to EN 12348. Reported data for noise pressure level has a typical statistical dispersion (standard deviation) of 1.0 dB(A).

Note 3: Vibration level according to EN 12348. Reported data for vibration level has a typical statistical dispersion (standard deviation) of 1  $m/s^2$ .

Gear	Drill bit speed with load, rpm	Drill bit load without load, rpm	Handheld drilling		Stand drilling	
			Recommended drill bit size, mm	Recommended drill bit size, inch	Recommended drill bit size, mm	Recommended drill bit size, inch
1	580	730	Not recommended	Not recommended	100-150	4-6
2	1400	1700	40-80	2-4	40-80	2-4
3	2900	3600	0-40	0-2	0-40	0-2

---

# TECHNICAL DATA

---

## EC-declaration of conformity

### (Applies to Europe only)

**Husqvarna AB**, SE-433 81 Göteborg, Sweden, tel: +46-31-949000, declares under sole responsibility that the **Husqvarna 230**, from 2010's serial numbers and onwards (the year is clearly stated in plain text on the rating plate with subsequent serial number), conforms with the requirements of the COUNCIL'S DIRECTIVE:

- of May 17, 2006 "relating to machinery" **2006/42/EC**
- of December 15, 2004 "relating to electromagnetic compatibility" **2004/108/EC**.
- of December 12, 2006 "relating to electrical equipment" **2006/95/EC**.

The following standards have been applied: EN ISO 12100:2003, EN 55014-1:2006, EN 55014-2/A1:2001, EN 61000-3-2:2006, EN 61000-3-3/A1/A2:2005, EN 60745-2-1:2007.

Gothenburg December 29, 2009

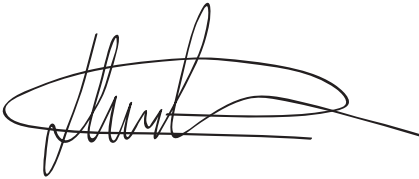

Henric Andersson

Vice President, Head of Power Cutters and Construction Equipment

Husqvarna AB

(Authorized representative for Husqvarna AB and responsible for technical documentation.)

# 符号说明

## 本机上的符号：

警告！本机非常危险！不小心或不正确的使用方式会对操作者或其他人员造成严重或者致命性伤害。



在使用前请详细阅读说明，并在充分了解动力切割机后才可开始使用。



在整个操作过程中，请务必佩戴：

- 检验合格的保护头盔
- 经检验合格的听觉保护设备
- 护目镜或面具
- 通气口罩



本产品符合适用欧盟指令要求。



环境标记。环境标记产品或其包装上的符号指示本产品不能作为生活垃圾处理。必须将它提交给相应的回收站以回收利用电气和电子设备。



对本产品进行不当的废物管理可能会对环境 and 人身造成负面影响，请确保正确处理本产品，帮助避免此问题。

有关回收本产品的更详细信息，请与您的市政当局、生活垃圾处理机构或销售本产品的商店联系。

在天花板上钻孔时，请务必防止机器进水。请使用一个适当的积水盘并在机器上盖上一层塑料，但切勿盖上进气口和出气口。



有关机器上的其他符号/图案，请参考适用于特定市场的特殊认证要求。

## 操作手册中的符号：

进行检查和/或维护时，应当关掉马达并且把插头从电源拔出。

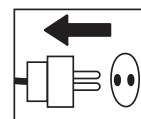

务必戴上检验合格的保护手套。

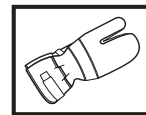

必须经常清洗。

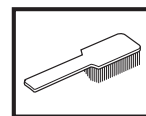

视检。

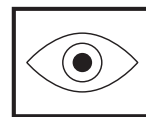

务必佩戴护目镜或面具。





---

# 目录

---

## 目录

### 符号说明

本机上的符号： .....16

操作手册里的符号： .....16

### 目录

目录 .....17

零组件图示说明钻机零件组图示说明？ .....17

### 安全须知

使用新的钻机前应采取的步骤 .....19

个人防护装备 .....19

### 安全须知

一般安全警告 .....20

一般作业说明 .....21

动力切割机的安全设备 .....22

动力切割机安全设备的检查、维修和保养 .....23

### 图示

DM 230 .....24

### 启动与停止

开始前 .....25

启动 .....25

停止 .....25

### 维修

概述 .....26

更换钻头 .....26

清洁 .....26

水龙头 .....26

电源 .....26

维修 .....26

更换齿轮箱油 .....26

更换碳刷 .....27

日常维护 .....27

### 技术资料

DM 230 .....28

WIRING DIAGRAM .....29

# 零组件图示说明

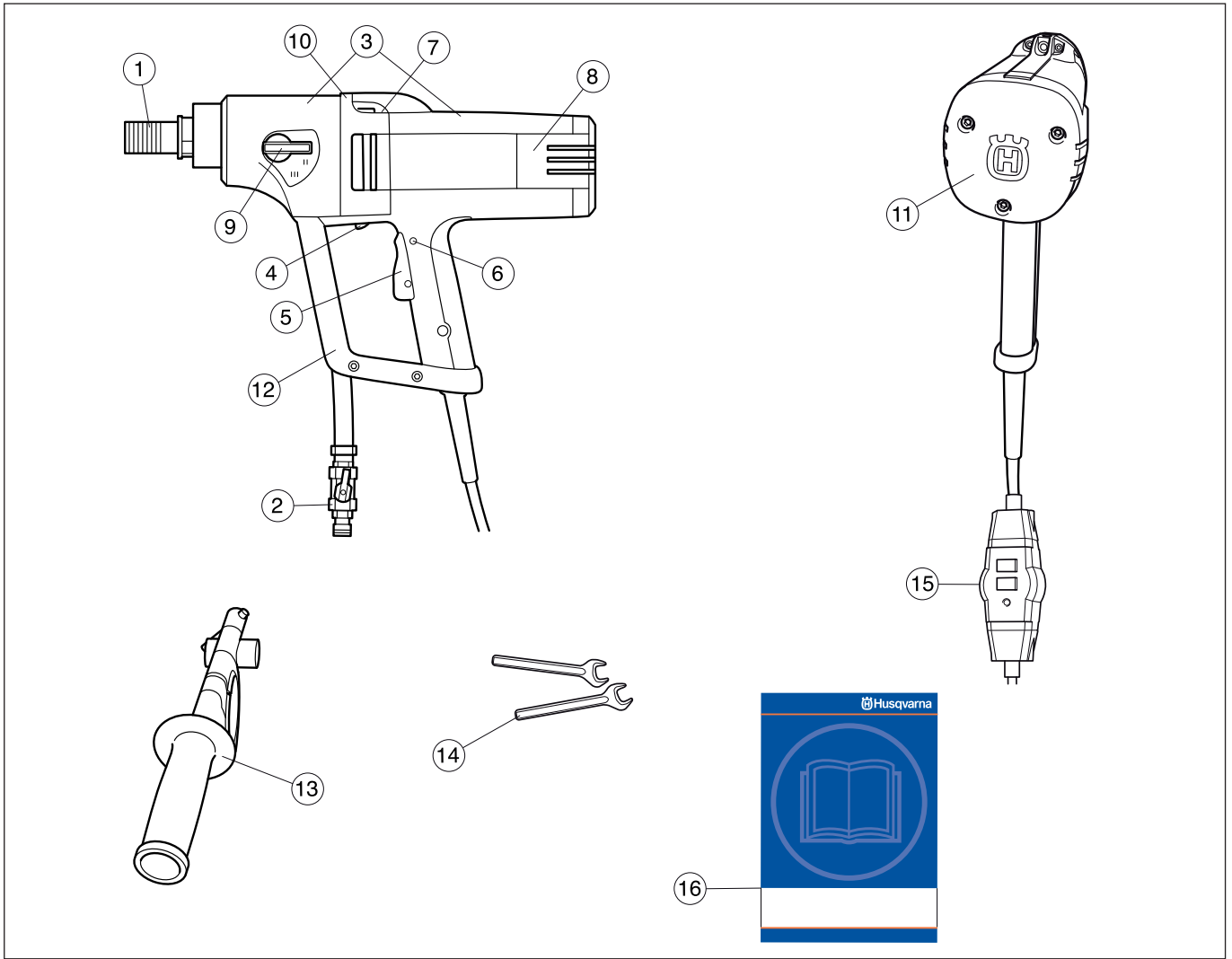

## 钻机零件组图示说明?

1. 钻轴
2. 水接头
3. 齿轮箱和马达模组
4. Smartstart™
5. 开关
6. 电源开关锁
7. 水准仪
8. 检查罩
9. 齿轮传动钮
10. 漏孔 (如果水或油从漏孔内流出, 请联系您的经销商更换密封件)
11. 加固物
12. 保护性撑杆和手提把手
13. 把手和适配器
14. 扳手
15. 漏电保护器
16. 操作手册

# 安全须知

## 使用新的钻机前应采取的步骤

- 在未阅读和理解本操作手册的内容之前，请勿使用本钻孔机。
- 本机仅可用于对混凝土、石料、砖造物及类似基材进行钻孔。切勿用于其他用途。
- 本机仅能由经验丰富的操作员在工业应用使用。

## 务必运用常识

不可能对您在使用钻机时可能遇到的情况一一点到。多加小心，并运用常识。在任何超出你能力范围的情况下，不要使用。如果在阅读本手册说明之后您对于操作程序依然不明，请在咨询专家后进行操作。如果您对于钻机的使用方法还有任何疑问，请随时与我们或您的经销商联系。我们将竭诚为您服务，并提供忠告与帮助，确保您高效安全地使用您的钻机。

如果您对于本机的使用方法还有任何疑问，请随时与您的经销商联系。我们将竭诚为您服务，并提供忠告与帮助，确保您高效安全地使用您的机器。

请您的 Husqvarna 经销商定期检查钻机，并进行必要的调整及修理。

连续开发产品是 Husqvarna Construction Products 的政策。因此，Husqvarna 保留修改产品设计和外观的权利，而无须事先通知，并且没有义务另行通知所修改的设计。

《操作手册》中的所有信息和数据在付印时皆可适用。



**警告！**在任何情况下，未经制造商批准，您都不得修改本机的原有设计。请始终使用原装备件。未经许可擅自修改，或使用未经认可的零件，可能导致严重的伤害或死亡。



**警告！**使用切割机、研磨机、钻孔机等产品时，磨砂或模板材料会产生可能含有有害化学物质的灰尘及蒸气。请确认加工材料的性质，并使用合适的通气口罩。

## 人身保护装备



**警告！**使用动力切割机时，一定要使用经检验合格的人身保护装备。人身保护装备不能避免发生意外的风险，但当意外发生时，可降低伤害程度。选择保护装备时，请向代理商查询。

- 保护头盔
- 听觉保护设备
- 护目镜或面具

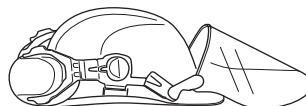

- 通气口罩

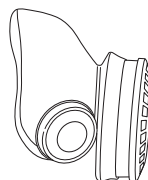

- 耐用可抓紧的保护手套。

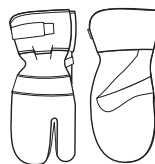

- 可让您活动自如，合身耐穿的衣物。



- 使用针对切割基材的护腿。
- 附钢制脚趾防护的防滑靴子。



- 急救箱随同在侧。



# 安全须知

## 一般安全警告



**警告！** 请阅读所有安全警告和所有说明。未按照警告和说明操作可能会导致电击、火灾和/或严重伤害。

保存所有警告和说明供以后参考。

警告中的术语“动力工具”指的是电力驱动（有线）的动力工具或电池操作（无线）的动力工具。

## 工作区安全

- 保持工作区干净明亮。混乱或黑暗的区域可能会导致事故。
- 请勿在诸如存在易燃液体、气体或粉尘等易爆炸的环境中操作动力工具。动力工具会生成火花，可能会点燃粉尘或气体。
- 操作动力工具时请远离儿童和旁观者。不专心操作将会无法控制工具。
- 避免在不良的天气情况下使用动力切割机。例如：浓雾、大雨、强风或是严寒等。在天气不良的情况下工作，容易令人感到疲倦，更可能造成危险的情况，例如湿滑的地面。
- 开始切割时，确定没有东西会松动或掉落，以至造成伤害。在斜路上工作时，尤其要特别小心。
- 当从头钻到尾时，请务必检查表面的后侧，钻头会从此处出来。固定并隔离此区域，确保不会伤害到任何人或损坏基材。

## 电气安全

- 动力工具的插头必须与插座匹配。切勿以任何方式改造插头。请勿将任何适配器插头与接地的动力工具一起使用。未经改造的插头和匹配的插座将减少电击风险。
- 避免将身体与接地表面接触，如管道、冷却器、炉具和冰箱。如果身体接地，则会增加遭受电击的风险。
- 请勿将动力工具暴露于雨中。动力工具中进水将会增加电击风险。
- 请勿滥用电线。切勿使用电线来支撑、拖拉或断开动力工具。请将电线远离热、油脂、尖锐边缘或移动的部件。损坏或缠绕的电线会增加电击风险。
- 在室外操作动力工具时，请使用适用于室外用途的伸延电线。使用适用于室外用途的电线会降低电击风险。
- 检查电线和伸延电线是否完好如初、状态良好。如果电线受损，请勿使用本机，将其送到授权的保养厂修理。
- 如果必须在潮湿环境中使用动力工作，电源必须配有漏电保护器。使用漏电保护器可减少电击风险。

- 请勿在伸延电线卷起时使用它以避免过热。
- 本机应接地线。检查电源电压是否与机器铭牌上的电压一致。
- 当您开始使用本机时，确保电线位于身后，以防受损。



**警告！** 请勿用水清洗本机，水进入电气系统或引擎将会导致机器损坏或短路。

## 人身安全

- 操作动力工具时，保持警觉并密切注意正在执行的操作并根据常识做出合理判断。请勿在疲倦或服用毒品、酒精或药物后使用动力工具。操作动力工具时的一时疏忽可能会导致严重的人身伤害。
- 佩戴个人防护装备。始终佩戴眼部保护设备。适用于相应条件的诸如面罩、防滑安全鞋、安全帽或听觉保护设备等保护装备可减少人身伤害。
- 防止意外启动。在连接至电源和/或电池组、提起或携带工具之前，确保开关处于关闭位置。将手指放在开关上携带动力工具或为打开开关的动力工具加电会引发事故。
- 打开动力工具电源前，请拔下任何调整钥匙或扳手。保持扳手或钥匙与动力工具的旋转部件相连接可能会导致人身伤害。
- 请勿距离过远。请始终维持适当的位置和平衡。这可在意外条件下更好地控制动力工具。
- 穿戴合适的服装。请勿穿宽松的服装或佩戴珠宝。保持头发、衣服和手套远离移动部件。宽松的服装、珠宝或长发可能会绞入移动部件中。
- 如果提供了用于连接吸尘和收集装置的设备，请确保正确连接和使用这些设备。使用吸尘装置可减少与灰尘有关的危险。
- 检查钻孔区是否有埋藏电缆或电线。
- 当您开始使用本机时，确保电线位于身后，以防受损。
- 在无人监督的情况下，切勿转动发动机。钻头旋转时可能会造成严重的人身伤害。
- 发动机在运转时，操作者须与钻头保持安全距离。
- 如果长时间停止工作，期间务必拔出本机的插头。
- 切勿单独工作，务必确保有另一个人在身旁。另一个人除了能够帮助您装配机器外，一旦发生任何事故，他还能向您提供帮助。

# 安全须知



**警告！**请使用本工具附带的辅助手柄。失控可能会造成人身伤害。



**警告！**血液循环不佳的人受到过度振动，可能会导致循环或是神经伤害。如果您因过度振动而引起以下症状，请自行就医。例如：麻痹、感觉迟钝、发痒、刺痛、痛楚、体力缺乏、肤色或病情的变化。这些症状大部分发生在手指、手或是手腕上。



**小心！**使用冲击钻时应使用听力保护装置。噪音过大可能导致听力下降。

## 动力工具的使用和维护

- 请勿强行操作动力工具。请针对具体用途使用正确的动力工具。正确的动力工具可更好更安全地按照设计用途完成工作。
- 请勿使用通过开关无法打开和关闭的动力工具。无法使用开关进行控制的任何动力工具都是危险的，必须进行维修。
- 进行任何调整、更改零件或存放动力工具前，请从动力工具的电源和/或电池组断开插头。此类预防性安全措施可降低不小心启动动力工具的风险。
- 请将闲置的动力工具存放在远离儿童的位置，不得允许不熟悉动力工具或这些说明的人员操作动力工具。未经培训的用户使用动力工具非常危险。
- 维护动力工具。检查是否存在未对齐或移动部件纠结、零件破损以及任何其他可能会影响动力工具操作的条件。如果已损坏，请在使用前维修动力工具。许多事故都是由未得到良好维护的动力工具造成的。
- 保持切割工具锋利洁净。具有锋利切割边缘的切割工具如果维护得当，不容易弯曲，并且更易于控制。
- 请按照这些说明使用动力工具、零件和刀头等，同时考虑工作环境以及要执行的任务。将动力工具用于非设计用途会导致危险。
- 千万不要使用曾对原设计进行任何改动之机器。
- 存放或是搬运钻机时，请将钻头卸下，这样才能防止您的钻机和钻头受到损坏。
- 切勿使机器过载。这样做会损坏机器。
- 保持所有部件处于正常状态并确保正确夹紧所有的夹持器。

## 维修

- 维修动力工具时，请联系合格的维修人员并仅使用相同的替换零件。这将确保动力工具的安全。

## 一般作业说明



**警告！**此节专注于使用钻机的基本安全事项。这些资料不能取代专业技能和经验。当你遇到任何疑问，不知如何继续进行的情况时，请请教专家。联络您的经销商、保养厂或有经验的钻机使用者。不要作没有把握的尝试！

- 本机具有非常高的扭矩力。工作期间必须高度集中注意力，因为一旦钻头突然间卡住，则可能会造成严重的人身伤害。
- 当机器运转时，您的双手须与钻轴和钻头保持安全距离。
- 密切观察油或水是否泄漏。如果水或油从小齿轮颈部上方的漏孔流出，则必须更换密封件。

## 手持式钻孔



**警告！**不要对第一个齿轮进行手持式钻孔，因为本机具有一个强劲的扭矩，一旦钻头卡住会造成人身伤害。

- 手持式钻孔时务必使用最大直径为 75 毫米的钻头。如果钻子卡住，则钻头越大，反应越大。
- 当进行手持式钻孔时，务必确保您站稳。

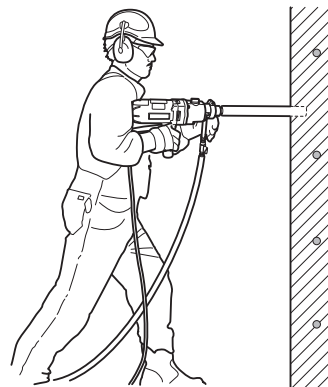

# 安全须知

## 钻台式钻孔

- 如果是从梯子或脚手架上进行钻孔，务必使用钻台。

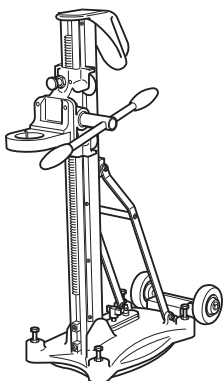

- 在上述情况下，手持式钻孔充满了危险，因为一旦钻头卡住，则极可能会坠落。



- 确保正确固定好钻台。
- 确保钻机正确固定在钻台上。

## 户外钻孔

- 务必使用那些已获批户外使用的伸延线。

## 在天花板等位置上进行钻孔

- 使用积水盘可避免机器进水。必须在机器上盖上一层塑料或类似物，以防止机器进水，但切勿盖住进气口和出气口。

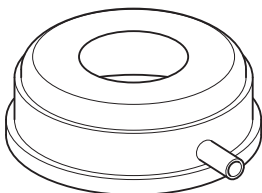

**重要事项！切勿盖住进气口**

## 动力切割机的安全设备

本部分介绍动力切割机的安全设备及其目的，并说明如何检查维修以确保切割机的正常运转。请参阅《零组件图示说明》部分，可找到此种安全设备在动力切割机上的正确位置。



**警告！切勿使用具有安全隐患的机器！必须检验与维修安全设备。请参阅《如何检查、维修及保养动力切割机的安全设备》篇的说明。如果您的机器未通过各项检查，请将其送至保养厂进行维修。**

## 开关

启动和停止本机，应使用电源开关。

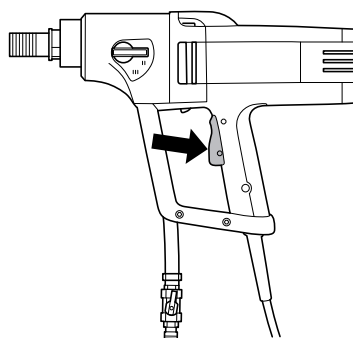

## 电源开关锁

电源开关锁设计用来预防开关的意外操作。当按下锁 (A) 时电源开关 (B) 被松开。

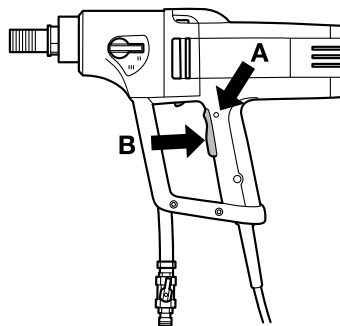

只要按下电源开关，电源开关锁即保持在按下状态。当把手上的夹具松开时，电源开关和电源开关锁都被复位。此动作是由两个独立的复位弹簧控制。这个位置使动力切割机停下来，使电源开关被锁定。

# 安全须知

## 漏电保护器

漏电保护器用于防止漏电。

LED 指示出漏电保护器是否打开以及机器能否打开。如果 LED 变亮，按下“RESET”按钮（绿色）。



## 动力切割机安全设备的检查、 维修和保养

**重要事项！**本机的保养和维修必须经过特别的培训。对于本机的安全设备来说尤其如此。如果在检修过程中出现下述的故障，应与保养厂联络。如果您购买我们的产品，我们承诺提供专业的修理和保养。如果出售本机的零售商不是保养商，应向他咨询离您最近的保养厂的地址。

### 检查电源开关锁

启动本机，松开电源开关，检查发电机和钻头是否停止。

应当由经过授权的保养厂替换有缺陷的电源开关。

### 检查电源开关

按下电源开关并检查按下电源开关锁时电源开关是否锁定。

按电源开关锁，确定开关在您松开手时能回到原来的位置。

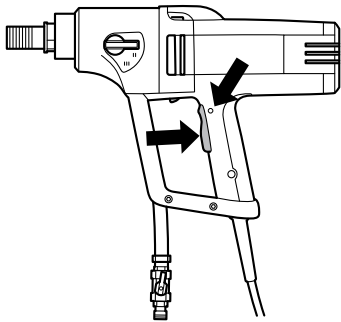

检查电源开关和电源开关锁是否自由移动。

## 检查漏电保护器

将机器连接到插座。按下“RESET”按钮（绿色），红色 LED 将变亮。

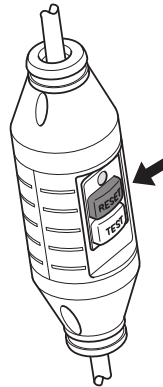

按下“TEST”（测试）按钮（蓝色）。≈=



漏电保护器应启动，机器也立即关闭。如果情况与此不同，请与您的经销商联系。

使用“RESET”按钮（绿色）进行复位。

## DM 230

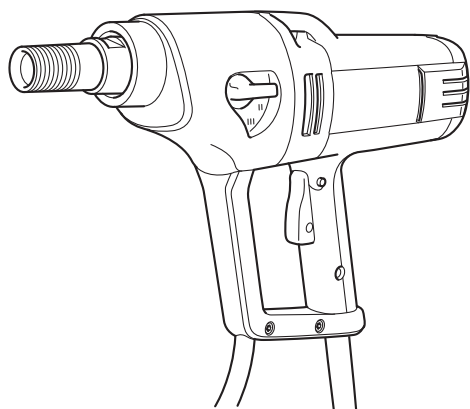

希望我们的产品让您称心如意并与您长期相伴。请将本操作手册视为重要文档。遵照其中的内容（使用、维修、保养等），机器的使用寿命及转让时的价值都将大大提高。如果您要转借或出售本机，请务必将本操作手册交给借用人或买主，以便让他们了解如何正确维护和使用本机。

购买我们的任意产品，您都将获得专业的修理和保养帮助。如果出售本机的零售商不是我们的授权经销商，应向他咨询离您最近的保养厂的地址。

连续开发产品是 Husqvarna Construction Products 的政策。因此，Husqvarna 保留修改产品设计和外观的权利，而无须事先通知，并且没有义务另行通知所修改的设计。

- DM 230 是一个电子手持式钻机，可用于对混凝土、石料、砖造物及类似基材进行钻孔。
- 钻机采用模块化设计且易于装配。
- 本机所装配的水准仪有利于钻孔，而带有支撑梢整合配接器的活动头手柄使工作变得更加舒适。
- DM 230 的钻头具有三个速度范围，尺寸达到 150 毫米。
- 本机具有一个水冷式齿轮箱和一条通过主轴的水管。
- DM 230 还可借助连接主轴的配接器连接至吸尘器进行干钻。
- 本钻机配有 Softstart™、Smartstart™、Elgard™ 和速度控制器。

## Softstart™

Softstart™ 是一种电子功率限制装置，可便于开始钻孔。当按下电源开关之后，大约三秒钟内即可达到最大速度。

## Smartstart™

如果按下电源开关后便直接按下 Smartstart™ 按钮，速度将减少 50%。在 Smartstart™ 模式下，本机的功率较低，直到再次按下此按钮为止。这些功能非常适用于建立一个导孔进行钻孔。

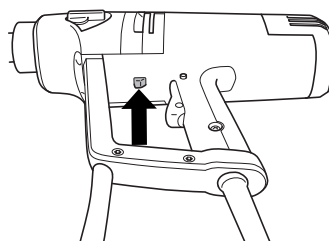

## Elgard™

Elgard™ 是一个电子过载保护装置。

如果发电机过载，过载保护装置将有节奏地驱动发电机。减少负荷量，发动机将返回到正常速度。如果机器重载或钻头卡住，过载保护装置将断开电源。重置机器时需要先松开电源开关，然后再次按下。如果钻头卡住，机械式滑动离合器将对齿轮箱进行保护，然后过载保护装置才会断开电源。

## 速度控制器

速度控制器始终从本机提供最大的输出功率。速度控制功能为本机提供有限的空转速度。

## 人体工程学

DM 230 柔软的后方部分有一大块的接触面，这样本机可以更好地放置在机身上。圆形的手柄便于在钻孔期间握紧。防护环在运输期间形成一个实用的手提把手。

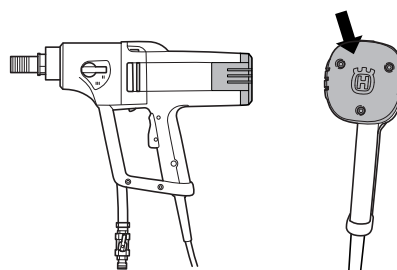



# 启动与停止

## 开始前



警告！启动前应注意以下事项：

本机应接地线。

检查电源电压是否与机器铭牌上的电压一致。

确定您站稳。让人和动物远离工作区。

确保：

- 开关没有损坏。否则，必须由一名经授权的维修人员来更换此开关。
- 开关没有粘住。
- 本机及其设备已正确安装：
  - 正确固定好钻机。
  - 如果使用钻台，则必须拴住齿轮箱上的颈部以连接至本机器。
- 穿戴个人防护装备。请参阅“个人防护装备”一节的说明。
- 将水冷式或吸尘器（借助配接器）连接至本机器上。根据所执行是水钻还是干钻来使用适当的钻头。如果有任何疑问，请联系您的经销商、保养厂或经验丰富的操作人员。

## 启动

**重要事项！只有在关闭机器后才能更换齿轮。否则可能会损坏齿轮箱。**

- 选择钻轴的同时将齿轮传动钮移到所需的位置上，即可设置工作速度。

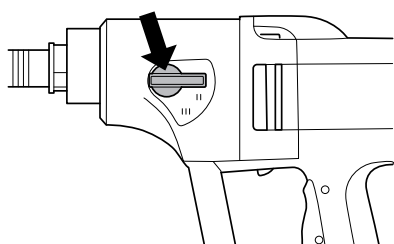

- 打开水冷却装置开关（湿钻）或吸尘器上的开关（干钻）。

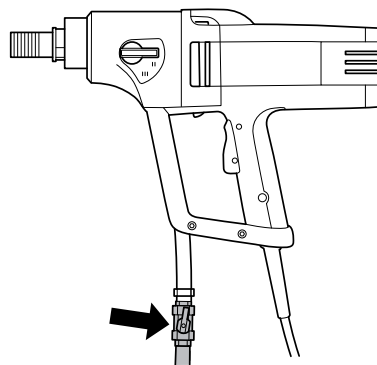

- 固定住机器。
- 完全按下开关。如果需要，还要按下 Smartstart™ 按钮。

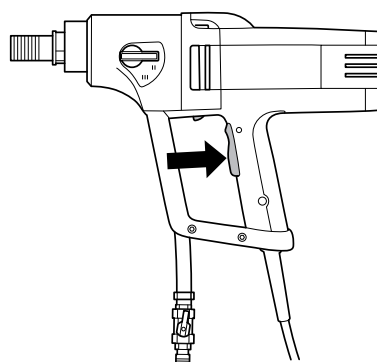

## 停止



警告！当关闭发动机之后，钻头将继续旋转一段时间。不要用手使钻头停止。否则可能会造成人身伤害。

松开电源开关，让马达停下来。

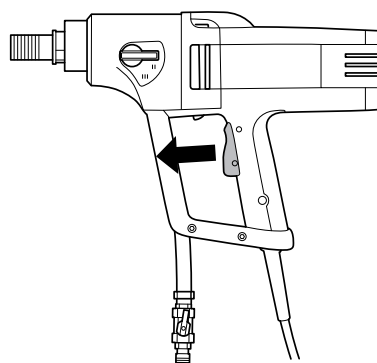

## 冷却

- 空转机器一分钟或两分钟，即可冷却发动机。

# 维修

## 通则



**警告！进行检查和/或维护时，应当关掉马达并且把插头从电源拔出。**

如果正确保养和维护，则能够大大延长机器的使用寿命。

## 更换钻头

- 拔出插头。
- 获取：
  - 新的钻头。
  - 随附的开口扳手，尺寸为 24 毫米和 32 毫米。
  - 防水的润滑脂。
- 使用开口扳手来拆除旧钻头。
- 将防水润滑脂涂抹到新钻头的螺纹上。
- 使用开口扳手来连接钻头。
- 在启动机器之前，请仔细检查新的钻头是否栓牢。

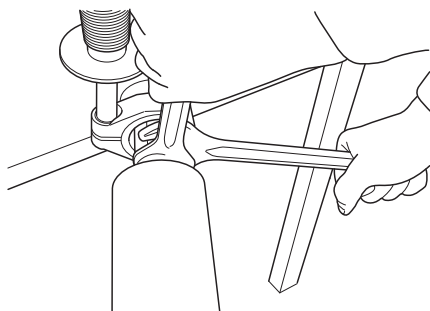

## 清洁

- 保持机器和钻头清洁，这样才能安全地进行钻孔。

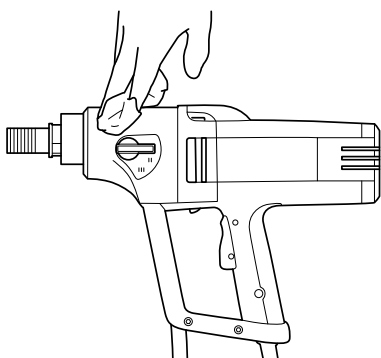

- 保持把手干燥、清洁，不沾润滑脂或油污。

- 为了使切割机有效冷却，冷却空气口必须保持畅通、清洁。定期用压缩空气吹切割机。

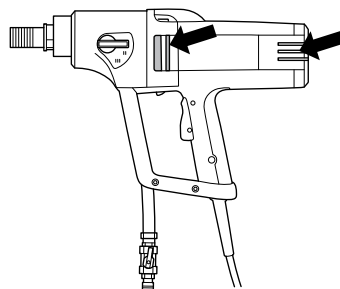

- 使用压缩空气定期清洁发动机。拆除检查罩并清洁罩子。

## 水龙头

- 检查水龙头是否运作正常。请勿使用扭曲、磨损或损坏的水管。

## 电源



**警告！切勿使用已损坏的电缆。这可能会导致严重怕甚至致命性人身伤害。**

检查电线和伸延电线是否完好如初、状态良好。如果电线受损，万勿使用本机，将其送到授权的保养厂修理。

## 维修

**切记，只有经授权的维修人员才能进行各种类型的维修。这可确保减小操作人员的风险。**

## 更换齿轮箱油

联系您的经销商获取正确的油。

每工作 400 个小时后必须更换齿轮箱油按下列操作：

- 获取：
  - 新油、Mobile Lube1 SHC 75W90 或其他类似的传动油。
  - 收集旧油的容器。
- 使用钻轴或类似物向下固定住机器。

# 维修

- 拧开固定发动机—齿轮箱模块的六个螺钉。

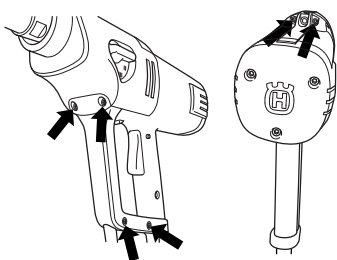

- 仔细拆卸机器。
- 将齿轮箱油倒空至容器内。
- 必要时，请联系您的经销商来清洗齿轮箱。
- 将大约 0.25 公升的新油倒入齿轮箱内。

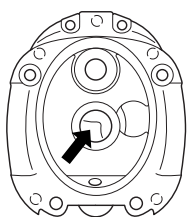

- 在发动机盖和齿轮箱盖之间安装一个 O 型环。请联系您的经销商以索取正确的 O 型环。

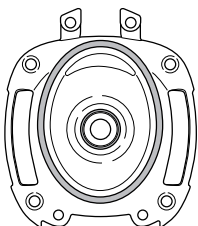

- 重新装配机器并拧入六个螺钉。

## 更换碳刷

必须定期拆除检查碳刷。如果每天使用机器，则每周检查一次，或者如果机器使用较少，则间隔时间变长。磨面应当平滑且完好如初。

务必成对更换碳刷，但一次只能更换一个。按下列操作：

- 取下检查罩的螺钉 3。

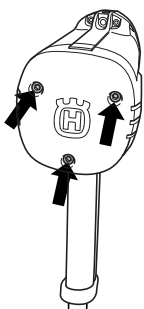

- 将碳刷架弹簧提到一侧 (A)。
- 松动螺钉 (B)。
- 拉出碳刷接头。

- 从支架上拉出碳刷 (C)。

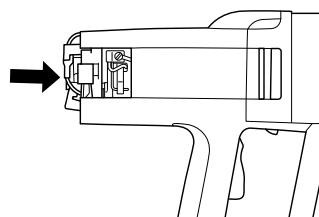

- 使用压缩空气或刷子清洗刷架。如果有磨损，请更换刷子。
- 装上新碳刷，同时检查其是否能在刷架内自由滑动。
- 将刷架弹簧归位。
- 在螺钉下方插入碳刷接头。
- 使用其他的碳刷重复执行此程序。
- 重新安装检查罩螺钉 3。将后方部分挤在一起，便于固定螺钉。确保检查罩插入其槽内。

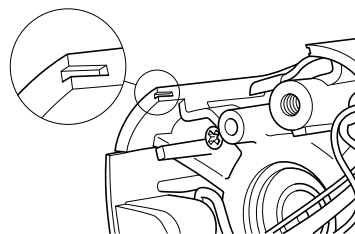

- 让机器闲置 10 分钟后才转动新的碳刷。

## 每天维修项目

- 1 检查螺母和螺钉是否上紧。
- 检查电源开关单元是否正常运作。
- 检查漏电保护器。
- 清洁机器的外部。
- 检查并清洁冷却空气口。
- 检查电线和伸延电线是否完好如初、状态良好。

# 技术资料

## DM 230

电机	单相
额定电压, V	230/100-120
额定功率, W	1850
额定电流, A	
230 V	8 A
100-120 V	15 A
重量, kg	7
钻头直径, mm	
带有钻台的钻头最大直径	150 mm (5,9" )
手持式钻头的最大直径	75 mm (3" )
心轴螺纹	G 1/2" G 1 1/4"
水接头	G 1/4"
水压 - 最大值, bar	8
钻台, mm	Ø 60 mm
噪音释放(参阅注 1)	
声能级, 量测值 dB(A)	107
声能级, 担保值 dB(A)	108
声级 (参阅注 2)	
操作人员耳边的声压级, dB(A)	93
振级 (参阅注 3)	
前侧把手, m/s <sup>2</sup>	2.8
后侧把手, m/s <sup>2</sup>	2.6

注 1：环境噪音释放以声能 (LWA) 量测，符合 EN 12348。

注 2：噪音音压位准符合 EN 12348。噪音音压位准的上报数据中具有一个 1.0 dB(A) 的典型统计离差（标准偏差）。

注 3：振级符合 EN 12348。振级的上报数据中具有一个 1 m/s<sup>2</sup> 的典型统计离差（标准偏差）。

齿轮	手持式钻孔		钻台式钻孔	
	钻头的负载速度, rpm	钻头空载速度, rpm	推荐的钻头尺寸, mm	推荐的钻头尺寸, inch
1	580	730	不建议	不建议
2	1400	1700	0-80	2-4
3	2900	3600	0-40	0-2

# WIRING DIAGRAM

DM 230

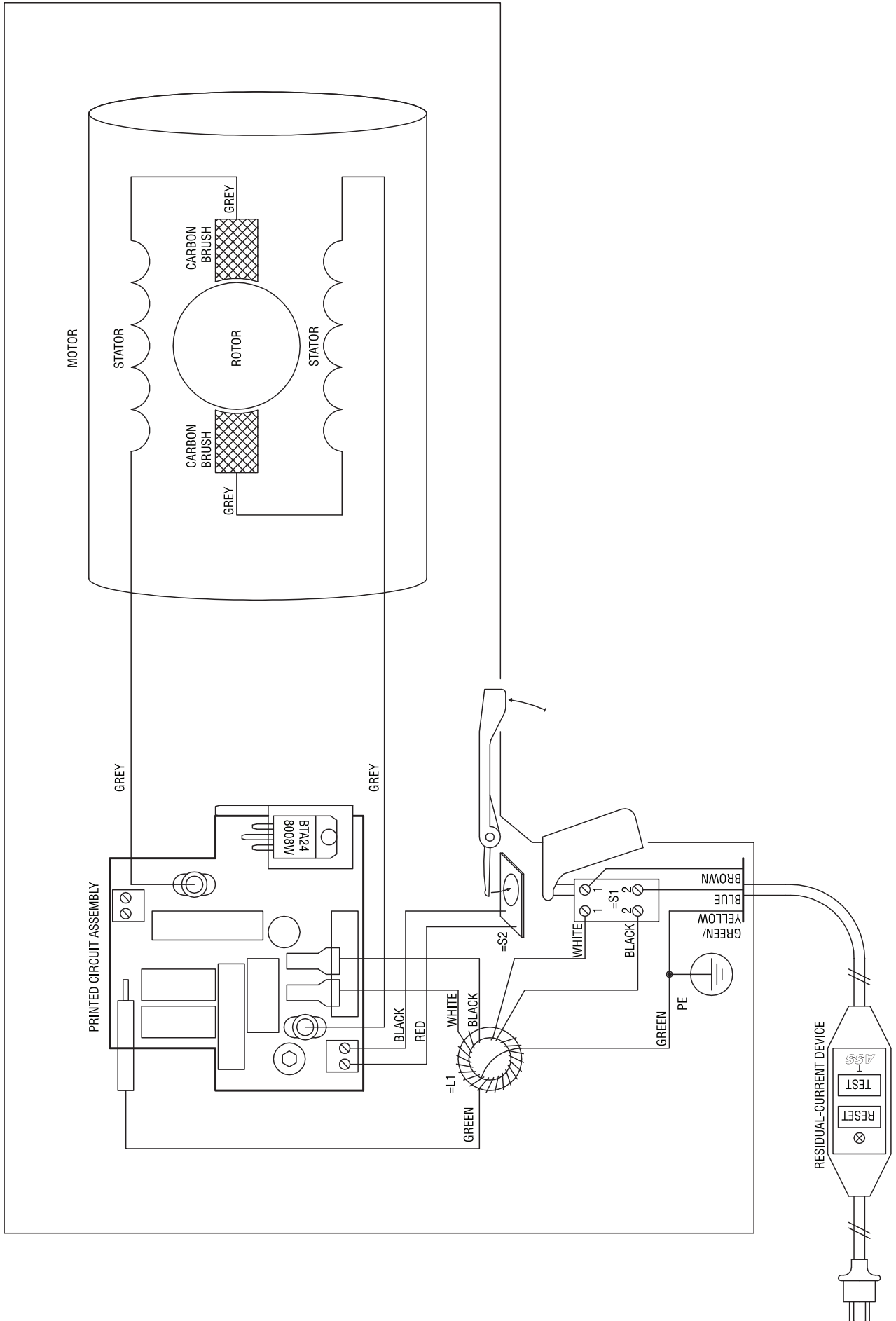





**EN – Original instructions    CN – 原始说明**



1154251-38

2014-09-12