



Husqvarna[®]



Operator's manual DM 230

Please read the operator's manual carefully and make sure you understand the instructions before using the machine.



GB

KEY TO SYMBOLS

Symbols on the machine:

WARNING! The machine can be a dangerous tool if used incorrectly or carelessly, which can cause serious or fatal injury to the operator or others.



Please read the operator's manual carefully and make sure you understand the instructions before using the machine.



Always wear:

- Approved protective helmet
- Approved hearing protection
- Protective goggles or a visor
- Breathing mask



This product is in accordance with applicable EC directives.



Environmental marking. Symbols on the product or its packaging indicate that this product cannot be handled as domestic waste. It must instead be submitted to an appropriate recycling station for the recovery of electrical and electronic equipment.



By ensuring that this product is taken care of correctly, you can help to counteract the potential negative impact on the environment and people that can otherwise result through the incorrect waste management of this product.

For more detailed information about recycling this product, contact your municipality, your domestic waste service or the shop from where you purchased the product.

Ensure that water cannot leak into the machine when drilling in the ceiling. Use an appropriate water collector and cover the machine in plastic, but do not cover the air intakes and air outlets.



Other symbols/decals on the machine refer to special certification requirements for certain markets.

Symbols in the operator's manual:

Inspection and/or maintenance should be carried out with the motor switched off and the plug disconnected.

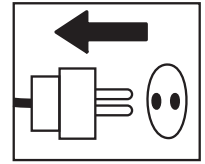

Always wear approved protective gloves.

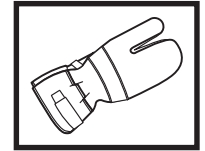

Regular cleaning is required.

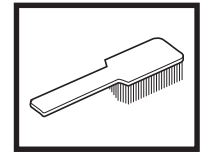

Visual check.

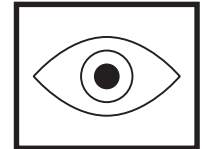

Protective goggles or a visor must be worn.



CONTENTS

Contents

KEY TO SYMBOLS

Symbols on the machine: 2

Symbols in the operator's manual: 2

CONTENTS

Contents 3

WHAT IS WHAT?

What is what on the drilling machine? 4

SAFETY INSTRUCTIONS

Steps before using a new drilling machine 5

Personal protective equipment 5

SAFETY INSTRUCTIONS

General safety warnings 6

General working instructions 7

Machine's safety equipment 8

Checking, maintaining and servicing the machine's
safety equipment 9

PRESENTATION

DM 230 10

STARTING AND STOPPING

Before starting 11

Starting 11

Stopping 11

MAINTENANCE

General 12

Changing the drill bit 12

Cleaning 12

Water tap 12

Electrical Feed 12

Repairs 12

Changing the gearbox oil 12

Replacing the carbon brushes 13

Daily maintenance 13

TECHNICAL DATA

EC-declaration of conformity 15

WIRING DIAGRAM

WHAT IS WHAT?

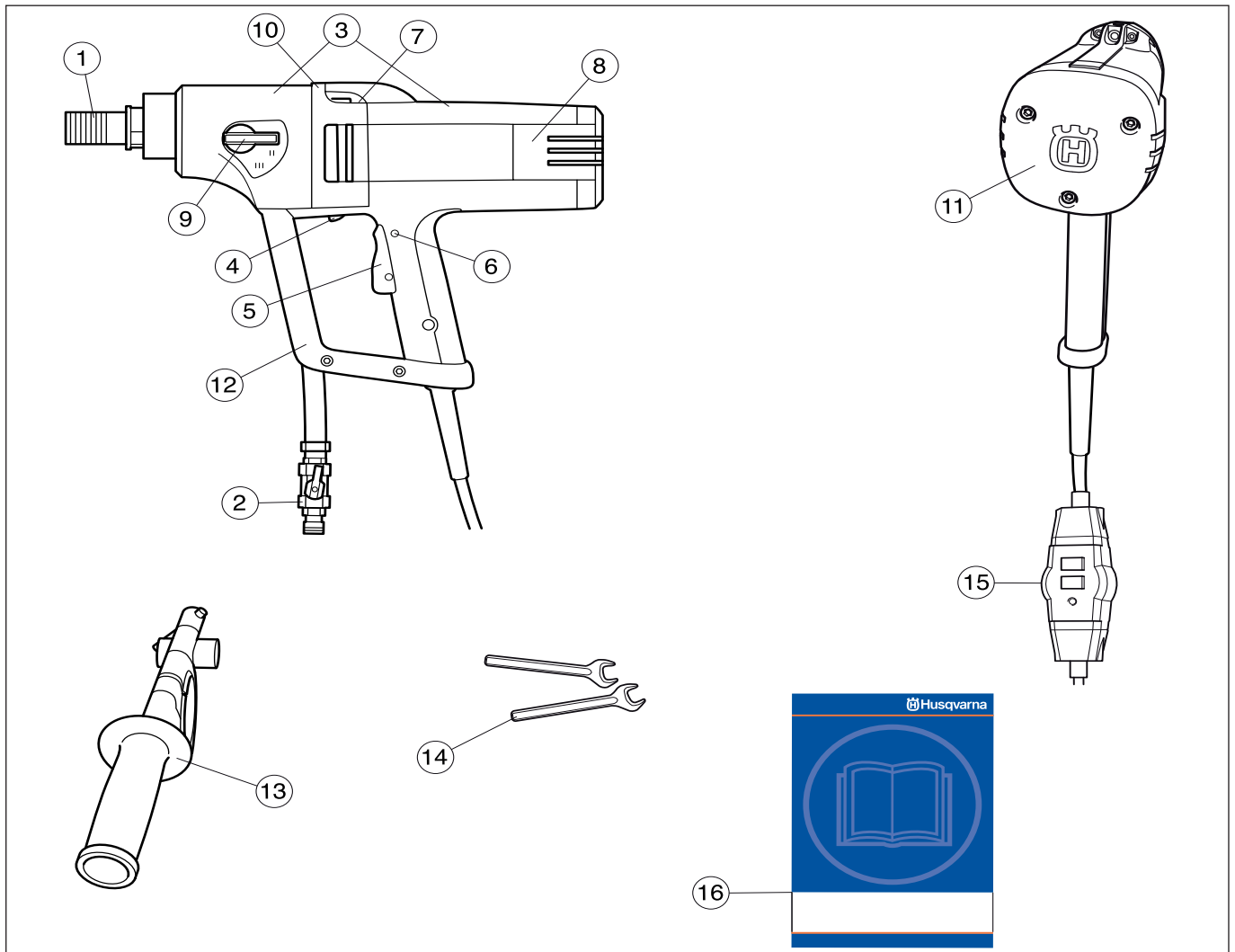

What is what on the drilling machine?

- | | |
|----------------------------|---|
| 1 Drill spindle | 9 Gear knob |
| 2 Water connector | 10 Leakage hole (if water or oil trickles out from the leakage hole contact your dealer to replace the seals) |
| 3 Gearbox and motor module | 11 Stiffener |
| 4 Smart Start® | 12 Protecting brace and carrying handle |
| 5 Power switch | 13 Handle and adapter |
| 6 Power switch lock | 14 Spanners |
| 7 Spirit level | 15 Ground fault circuit interrupter |
| 8 Inspection cover | 16 Operator's manual |

SAFETY INSTRUCTIONS

Steps before using a new drilling machine

- Do not use the drilling machine without first reading and understanding the contents of this Operator's Manual.
- This machine is designed for and intended for drilling concrete, brick and different stone materials. All other use is improper.
- The machine is intended for use in industrial applications by experienced operators.

Always use common sense

It is not possible to cover every conceivable situation you can face when using a drilling machine. Always exercise care and use your common sense. Avoid all situations which you consider to be beyond your capability. If you still feel uncertain about operating procedures after reading these instructions, you should consult an expert before continuing. Do not hesitate to contact your dealer or us if you have any more questions about the use of the drilling machine. We will willingly be of service and provide you with advice as well as help you to use your drilling machine both efficiently and safely.

Do not hesitate to contact your dealer if you have any more questions about the use of the machine. We will willingly be of service and provide you with advice as well as help you to use your machine both efficiently and safely.

Let your Husqvarna dealer check the drilling machine regularly and make essential adjustments and repairs.

Husqvarna Construction Products has a policy of continuous product development. Husqvarna reserves the right to modify the design and appearance of products without prior notice and without further obligation introduce design modifications.

All information and all data in the Operator's Manual were applicable at the time the Operator's Manual was sent to print.



WARNING! Under no circumstances should you modify the original design of the machine without approval from the manufacturer. Always use original spare parts. Unauthorized modifications and/or accessories may lead to serious injury or death to the user or others.



WARNING! The use of products such as cutters, grinders, drills, that sand or form material can generate dust and vapours which may contain hazardous chemicals. Check the nature of the material you intend to process and use an appropriate breathing mask.

Personal protective equipment



WARNING! You must use approved personal protective equipment whenever you use the machine. Personal protective equipment cannot eliminate the risk of injury but it will reduce the degree of injury if an accident does happen. Ask your dealer for help in choosing the right equipment.

- Protective helmet
- Hearing protection
- Protective goggles or a visor

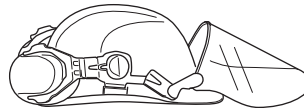

- Breathing mask

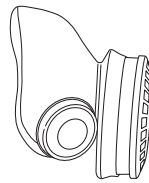

- Heavy-duty, firm grip gloves.

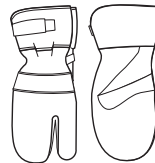

- Tight-fitting, heavy-duty and comfortable clothing that permits full freedom of movement.



- Boots with steel toe-caps and non-slip sole.



- Always have a first aid kit nearby.



SAFETY INSTRUCTIONS

General safety warnings



WARNING! Read all safety warnings and all instructions. Failure to follow the warnings and instructions may result in electric shock, fire and/or serious injury.

Save all warnings and instructions for future reference.

The term "power tool" in the warnings refers to your mains-operated (corded) power tool or battery-operated (cordless) power tool.

Work area safety

- Keep work area clean and well lit. Cluttered or dark areas invite accidents.
- Do not operate power tools in explosive atmospheres, such as in the presence of flammable liquids, gases or dust. Power tools create sparks which may ignite the dust or fumes.
- Keep children and bystanders away while operating a power tool. Distractions can cause you to lose control.
- Do not use the machine in bad weather, such as dense fog, rain, strong wind, intense cold, etc. Working in bad weather is tiring and can lead to dangerous conditions, e.g. slippery surfaces.
- Ensure when cutting that no material can become loose and fall, causing operating injury. Take great care when working on sloping ground.
- Always check the rear side of the surface where the drill bit will emerge when drilling right through. Secure and cordon off the area and make sure that no one can be injured or material damaged.

Electrical safety

- Power tool plugs must match the outlet. Never modify the plug in any way. Do not use any adapter plugs with earthed (grounded) power tools. Unmodified plugs and matching outlets will reduce the risk of electric shock.
- Avoid body contact with earthed or grounded surfaces, such as pipes, radiators, ranges and refrigerators. There is an increased risk of electric shock if your body is earthed or grounded.
- Do not expose power tools to rain or wet conditions. Water entering a power tool will increase the risk of electric shock.
- Do not abuse the cord. Never use the cord for carrying, pulling or unplugging the power tool. Keep cord away from heat, oil, sharp edges or moving parts. Damaged or entangled cords increase the risk of electric shock.
- When operating a power tool outdoors, use an extension cord suitable for outdoor use. Use of cord suitable for outdoor use reduces the risk of electric shock.
- Check that the cord and extension cord are intact and in good condition. Never use the machine if the cord is damaged, hand it in to an authorized service workshop for repair.

- If operating a power tool in a damp location is unavoidable, use a ground fault circuit interrupter protected supply. Use of an GFCI reduces the risk of electric shock.
- To avoid overheating do not use the extension cord while it is rolled up.
- The machine should be connected to an earthed outlet socket. Check that the mains voltage corresponds with that stated on the rating plate on the machine.
- Ensure the cord is behind you when you start to use the machine so that the cord will not be damaged.



WARNING! Do not wash the machine with water, as water can enter the electrical system or the engine and cause damage to the machine or short circuit.

Personal safety

- Stay alert, watch what you are doing and use common sense when operating a power tool. Do not use a power tool while you are tired or under the influence of drugs, alcohol or medication. A moment of inattention while operating power tools may result in serious personal injury.
- Use personal protective equipment. Always wear eye protection. Protective equipment such as dust mask, non-skid safety shoes, hard hat, or hearing protection used for appropriate conditions will reduce personal injuries.
- Prevent unintentional starting. Ensure the switch is in the OFF-position before connecting to power source and/or battery pack, picking up or carrying the tool. Carrying power tools with your finger on the switch or energising power tools that have the switch on invites accidents.
- Remove any adjusting key or wrench before turning the power tool on. A wrench or a key left attached to a rotating part of the power tool may result in personal injury.
- Do not overreach. Keep proper footing and balance at all times. This enables better control of the power tool in unexpected situations.
- Dress properly. Do not wear loose clothing or jewellery. Keep your hair, clothing and gloves away from moving parts. Loose clothes, jewellery or long hair can be caught in moving parts.
- If devices are provided for the connection of dust extraction and collection facilities, ensure that these are connected and properly used. Use of dust collection can reduce dust-related hazards.
- Make sure that no pipes or electrical cables are routed in the area to be drilled.
- Ensure the cord is behind you when you start to use the machine so that the cord will not be damaged.
- Never leave the machine unsupervised with the motor running. A rotating drill bit can entail a risk of serious injury.
- Remain at a distance from the drill bit when the motor is running.
- Always unplug the machine during longer work breaks.

SAFETY INSTRUCTIONS

- Never work alone, always ensure there is another person close at hand. Apart from being able to receive help to assemble the machine, you can also get help if an accident should occur.



WARNING! Use auxiliary handles supplied with the tool. Loss of control can cause personal injury.



WARNING! Overexposure to vibration can lead to circulatory damage or nerve damage in people who have impaired circulation. Contact your doctor if you experience symptoms of overexposure to vibration. These symptoms include numbness, loss of feeling, tingling, pricking, pain, loss of strength, changes in skin colour or condition. These symptoms normally appear in the fingers, hands or wrists.



CAUTION! Wear ear protectors with impact drills. Exposure to noise can cause hearing loss.

Power tool use and care

- Do not force the power tool. Use the correct power tool for your application. The correct power tool will do the job better and safer at the rate for which it was designed.
- Do not use the power tool if the switch does not turn it on and off. Any power tool that cannot be controlled with the switch is dangerous and must be repaired.
- Disconnect the plug from the power source and/or the battery pack from the power tool before making any adjustments, changing accessories, or storing power tools. Such preventive safety measures reduce the risk of starting the power tool accidentally.
- Store idle power tools out of the reach of children and do not allow persons unfamiliar with the power tool or these instructions to operate the power tool. Power tools are dangerous in the hands of untrained users.
- Maintain power tools. Check for misalignment or binding of moving parts, breakage of parts and any other condition that may affect the power tool's operation. If damaged, have the power tool repaired before use. Many accidents are caused by poorly maintained power tools.
- Keep cutting tools sharp and clean. Properly maintained cutting tools with sharp cutting edges are less likely to bind and are easier to control.
- Use the power tool, accessories and tool bits etc. in accordance with these instructions, taking into account the working conditions and the work to be performed. Use of the power tool for operations different from those intended could result in hazardous situations.
- Never use a machine that has been modified in any way from its original specification.
- Do not store or transport the drilling machine with the drill bit fitted in order to protect your drilling machine and drill bits from damage.

- Do not overload the machine. Overloading can damage the machine.
- Keep all parts in good working order and ensure that all fixtures are properly tightened.

Service

- Have your power tool serviced by a qualified repair person using only identical replacement parts. This will ensure that the safety of the power tool is maintained.

General working instructions



WARNING! This section takes up the basic safety precautions for working with the drilling machine. This information is never a substitute for professional skills and experience. If you encounter a situation where you are uncertain how to proceed you should ask an expert. Contact your dealer, service agent or an experienced drilling machine user. Do not attempt any task that you feel unsure of!

- The machine has a very high torque. This demands good concentration during work, as serious personal injuries can occur if the drill bit suddenly jams.
- Keep your hands at a safe distance from the drill spindle and drill bit when the machine is running.
- Keep an eye open for oil or water leakage. If water or oil trickles out from the leakage hole on the top of the pinion neck, the seals must be replaced.

Handheld drilling



WARNING! Do not perform handheld drilling in first gear as the machine has a powerful torque that can result in personal injuries should the drill bit jam.

- Always use a drill bit with a max. diameter of 75 mm with handheld drilling. The larger the drill bit the greater the reaction if the drill jams.
- Always make sure you are standing firmly when carrying out handheld drilling.

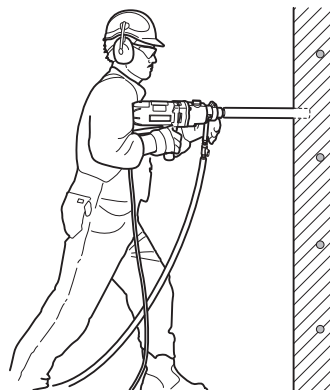

SAFETY INSTRUCTIONS

Stand drilling

- Always use a drilling stand if drilling is to be performed from a ladder or scaffold.

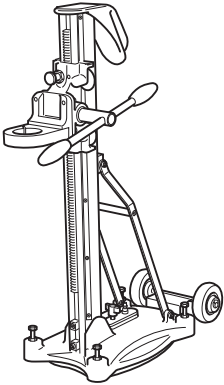

Handheld drilling in these situations is full of risks, as the risk of falling is very high if the drill bit jams.



- Make sure that the stand is secured correctly.
- Make sure that the drilling machine is secured correctly in the stand.

Drilling outdoors

- Always use extension cables that are approved for outdoor use.

Drilling in ceilings and the like

- Use a water collector to avoid water penetrating into the machine. The machine must be covered with plastic or the like in order to prevent water penetrating into the machine, but do not cover the air intakes and air outlets.

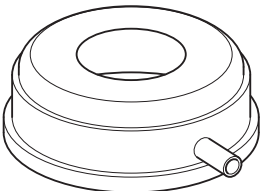

IMPORTANT! The air intake must not be covered.

Machine's safety equipment

This section describes the machine's safety equipment, its purpose, and how checks and maintenance should be carried out to ensure that it operates correctly. See the "What is what?" section to locate where this equipment is positioned on your machine.



WARNING! Never use a machine that has faulty safety equipment! Safety equipment must be inspected and maintained. See instructions under the heading **Checking, maintaining and servicing the machine's safety equipment**. If your machine does not pass all the checks, take it to a service workshop for repair.

Power switch

The power switch should be used to start and stop the machine.

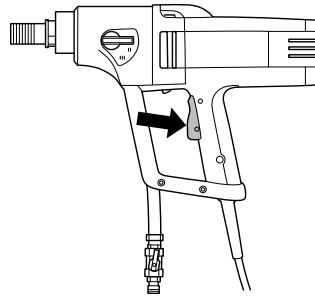

Power switch lock

The power switch lock is designed to prevent accidental operation of the switch. When the lock (A) is pressed in the power switch (B) is released.

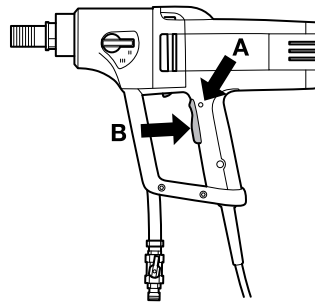

The power switch lock remains depressed as long as the power switch is depressed. When the grip on the handle is released both the power switch and power switch lock are reset. This movement is controlled by two independent return springs. This position results in the machine stopping and the power switch being locked.

SAFETY INSTRUCTIONS

Ground fault circuit interrupter

Ground fault circuit interrupters are for protection in case an electrical fault should occur.

The LED indicates that the ground fault circuit interrupter is on and that the machine can be switched on. If the LED is not on, push the RESET button (green).



Checking, maintaining and servicing the machine's safety equipment



IMPORTANT! All servicing and repair work on the machine requires special training. This is especially true of the machine's safety equipment. If your machine fails any of the checks described below you must contact your service agent. When you buy any of our products we guarantee the availability of professional repairs and service. If the retailer who sells your machine is not a servicing dealer, ask him for the address of your nearest service agent.

Checking the power switch

Start the machine, release the power switch and check that the motor and the drill bit stop.

A defective power switch should be replaced by an authorized service workshop.

Checking the power switch lock

Press the power switch and check that the power switch is locked when the power switch lock is pressed in.

Press in the power switch and make sure the switch returns to its original position when you release it.

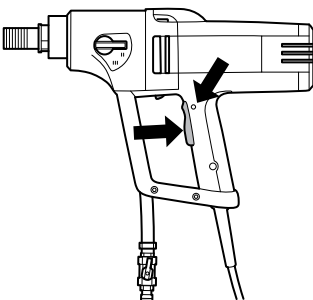

Check that the power switch and the power switch lock move easily.

Check the ground fault circuit interrupter

Connect the machine to the socket. Push the RESET button (green) and the red LED lights up.



Push the TEST button (blue).



The ground fault circuit interrupter should trip and the machine switch off instantly. If not, contact your dealer.

Reset with the RESET button (green).

PRESENTATION

DM 230

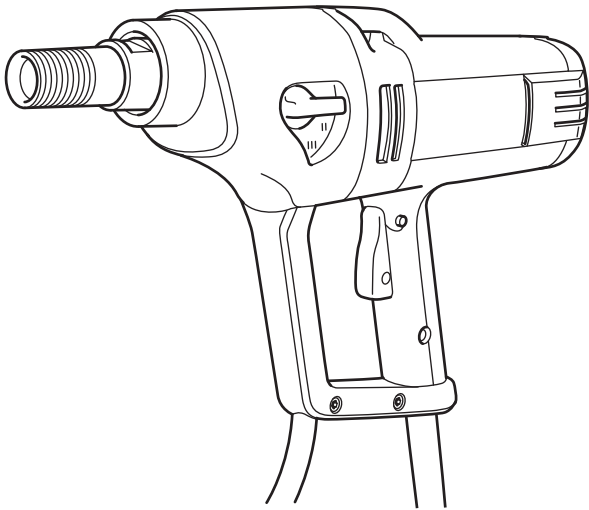

It is our wish that you will be satisfied with your product and that it will be your companion for a long time. Think of this operator's manual as a valuable document. By following its' content (using, service, maintenance etc) the life span and the second-hand value of the machine can be extended. If you will sell this machine, make sure that the buyer will get the operator's manual.

A purchase of one of our products gives you access to professional help with repairs and services. If the retailer who sells your machine is not one of our authorised dealers, ask him for the address of your nearest service workshop.

Husqvarna Construction Products has a policy of continuous product development. Husqvarna reserves the right to modify the design and appearance of products without prior notice and without further obligation introduce design modifications.

- The DM 230 is an electric handheld drill, intended for drilling concrete, brick and various stone materials.
- The drilling machine has a modular design and is easy to assemble.
- The machine is equipped with spirit levels to facilitate drilling and a swivel handle with an integrated adapter for support pins to make the work more comfortable.
- DM 230 has three speed ranges for drill bit sizes up to 150 mm.
- The machine has a water cooled gearbox with a pipe that runs through the spindle.
- DM 230 can also be connected to a vacuum cleaner with the help of an adapter, used for dry drilling, which is attached to the spindle.
- The drilling machine is equipped with Softstart™, Smartstart™, Elgard™ and speed control.

Softstart™

Softstart™ is an electronic power limitation, making it easier to start the drill. Maximum speed is reached in about three seconds after the power switch is pressed in.

Smartstart™

If the Smartstart™ button is pressed in directly after the power switch is pressed in, the speed is reduced by 50%. In Smartstart™ mode the machine has less power until the button is pressed in again. These functions are of great use for creating a pilot hole for drilling.

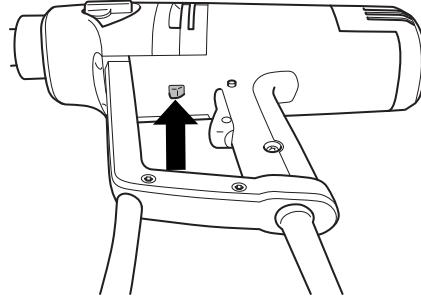

Elgard™

Elgard™ is an electronic overload protection.

If the motor is overloaded, the overload protection pulses the motor. Reduce the load and the motor returns to its normal speed. The overload protection disconnects the power, if the machine is subjected to heavy loads or if the drill bit jams. The machine is reset by first releasing the power switch and then pressing it in again. If the drill bit jams, the mechanical slip clutch protects the gearbox before the overload protection disconnects the power.

Speed control

Speed control always gives maximum output power from the machine. The speed control function provides the machine with a limited idling speed.

Ergonomics

The soft rear section on the DM 230 has a large contact area so that the machine sits better against the body. The rounded handle makes the machine comfortable to hold while drilling. The protective loop forms a practical carry handle when transporting.

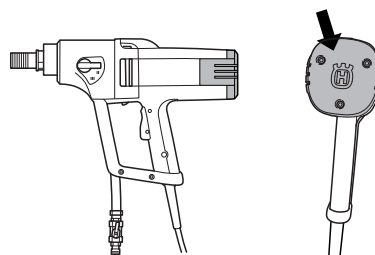

STARTING AND STOPPING

Before starting



WARNING! Note the following before starting:

The machine should be connected to an earthed outlet socket.

Check that the mains voltage corresponds with that stated on the rating plate on the machine.

Ensure you stand firmly. Keep people and animals well away from the working area.

Make sure that:

- The switch is undamaged. If not, the switch must be replaced by an authorised repairman.
- The switch is not sticking.
- The machine and its equipment are correctly installed:
 - The drill is secured properly.
 - If a stand is used, it must be attached to the machine by the fastening neck on the gearbox.
- Wear personal protective equipment. See instructions under the heading "Personal protective equipment".
- The water cooling or vacuum cleaner (with the help of adapter) are attached to the machine. Use suitable drill bits depending on whether water or dry drilling is being performed. In the event of uncertainty contact your dealer, your service workshop or an experienced operator.

Starting

IMPORTANT! Changing gear may only be done when the machine is switched off. Otherwise there is a risk of damaging the gearbox.

- 1 Set the working speed by turning the drill spindle and at the same time move the gear knob to the required position.

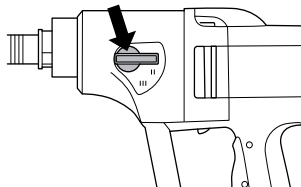

- 2 Turn on the water cooling (wet drilling) or switch on the vacuum cleaner (dry drilling).

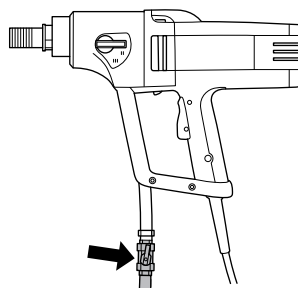

- 3 Hold the machine steady.
- 4 Press in the switch fully. Also press, if desired, the Smartstart™ button.

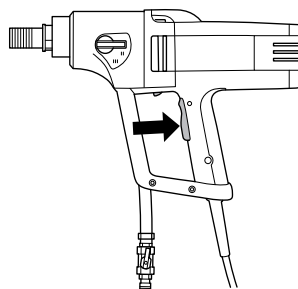

Stopping



WARNING! The drill bit continues to rotate for a while after the motor has been switched off. Do not stop the drill bit with your hands. Personal injuries can occur.

Stop the motor by releasing the power switch.

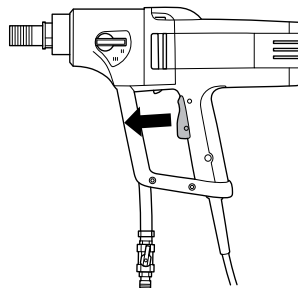

Cooling

Run the machine unloaded for a minute or two to cool the motor.

MAINTENANCE

General



WARNING! Inspection and/or maintenance should be carried out with the motor switched off and the plug disconnected.

The lifetime of your machine can be extended considerably if it is used, cared for and maintained in the proper manner.

Changing the drill bit



- 1 Pull out the plug.
- 2 Get:
 - The new drill bit.
 - The supplied open-ended spanners, size 24 mm and 32 mm.
 - Water-resistant grease.
- 3 Remove the old drill bit using the open-ended spanners.
- 4 Apply water-resistant grease to the thread of the new drill bit.
- 5 Attach the drill bit using the open-ended spanners.

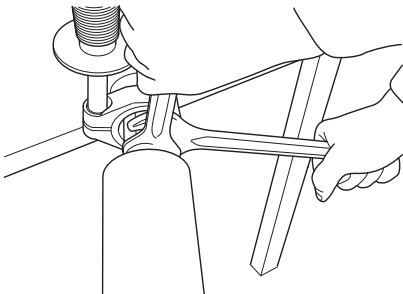

Before the machine is started, carefully check that the new bit is firmly attached.

Cleaning

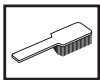

- Keep the machine and drill bit clean in order for drilling to be carried out safely.

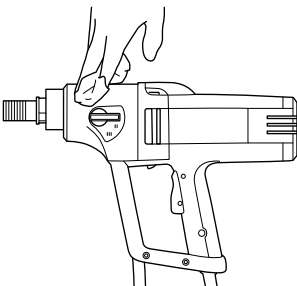

- Keep the handle dry and free of grease and oil.

- In order for the machine to always be cooled sufficiently the cooling air openings must be kept clear and clean. Blow down the machine regularly with compressed air.

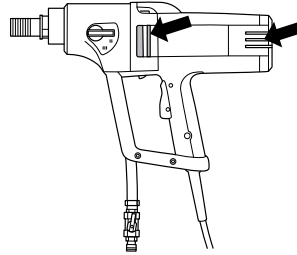

- Use compressed air to periodically clean the motor. Remove the inspection cover and clean the cover.

Water tap

Check that the water tap functions. Do not use hoses that are distorted, worn or damaged.

Electrical Feed



WARNING! Never use damaged cables. They can cause serious, even fatal, personal injuries.

Check that the cord and extension cord are intact and in good condition. Never use the machine if the cord is damaged, hand it in to an authorized service workshop for repair.

Repairs

Important All types of repairs may only be carried out by authorised repairmen. This is so that the operators are not exposed to great risks.

Changing the gearbox oil



Contact your dealer to get the right oil.

The oil in the gearbox must be changed after every 400 hours of operation. Do as follows:

- 1 Get:
 - New oil, Mobile Lube1 SHC 75W90 or other similar transmission oil.
 - A container for the old oil.
- 2 Secure the machine with drill spindle downwards in a vice or the like.

MAINTENANCE

- Unscrew the six screws holding the motor - gearbox modules together.

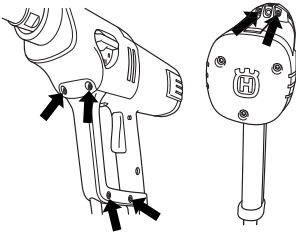

- Carefully disassemble the machine.
- Empty the gearbox oil into the container.
- If necessary contact your dealer to clean the gearbox.
- Pour the new oil into the gearbox, about 0.25 litres.

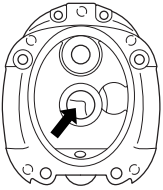

- Fit a new O-ring between the motor cover and the gearbox cover. Contact your dealer to receive the correct O-ring.

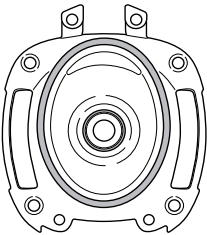

- Reassemble the machine and screw in the six screws.

Replacing the carbon brushes



The carbon brushes must be removed and checked regularly. Weekly if the machine is used daily or at longer intervals if the machine is used more seldom. The area of wear should be even and undamaged.

Both carbon brushes must always be replaced as a pair, but one at a time. Do as follows:

- Remove the inspection cover's screws, 3.



- Lift the carbon brush holder spring to one side.
- Loosen the screw.
- Pull out the carbon brush connector.

- Pull the carbon brush out from the holder.

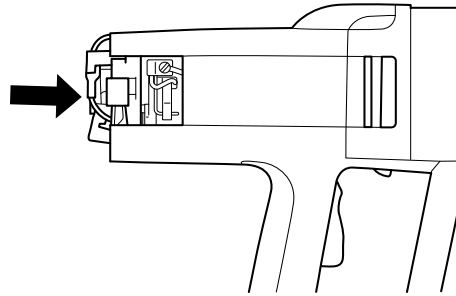

- Clean the brush holder with compressed air or a brush. Replace the brush if worn.
- Fit the new carbon brushes and, at the same time, check that they slide easily in the brush retainers.
- Put the brush holder spring back into place.
- Insert the carbon brush connection under the screw.
- Repeat the procedure with the other carbon brush.
- Refit the inspection cover screws, 3. Press together the rear section to make it easier to secure the screws. Make sure that the inspection cover enters its slots.

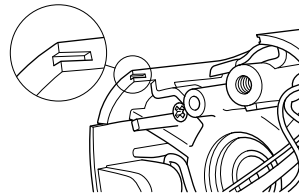

- Let the machine idle for 10 minutes to run in the new carbon brushes.

Daily maintenance



- Check that nuts and screws are tight.
- Check that the power switch unit works smoothly.
- Check the ground fault circuit interrupter.
- Clean the outside of the machine.
- Check and clean the cooling air openings.
- Check that the cord and extension cord are intact and in good condition.

TECHNICAL DATA

DM 230

Electric motor	Single-phase
Rated voltage, V	220-240/100-120
Rated output, W	1850

Rated current, A

220-240 V	8 A
100-120 V	15 A

Weight, kg	7
------------	---

Diameter drill bit, mm

Max. diameter of the drill bit, with stand	150 mm (5,9")
Max. diameter for the drill bit, handheld	75 mm (3")

Spindle thread	G 1/2"	G 1 1/4"
Water connector	G 1/4"	
Water pressure - max, bar	8	

Stand, mm	Ø 60 mm
-----------	---------

Noise emissions (see note 1)

Sound power level, measured dB(A)	107
Sound power level, guaranteed dB(A)	108

Sound levels (see note 2)

Sound pressure level at the operators ear, dB(A)	93
--	----

Vibration levels, a_{HV} (see note 3)

Front handle, m/s^2	2,8
Rear handle, m/s^2	2,6

Note 1: Noise emissions in the environment measured as sound power (L_{WA}) in conformity with EN 12348.

Note 2: Noise pressure level according to EN 12348. Reported data for noise pressure level has a typical statistical dispersion (standard deviation) of 1.0 dB(A).

Note 3: Vibration level according to EN 12348. Reported data for vibration level has a typical statistical dispersion (standard deviation) of 1 m/s^2 .

Gear	Drill bit speed with load, rpm	Drill bit load without load, rpm	Handheld drilling		Stand drilling	
			Recommended drill bit size, mm	Recommended drill bit size, inch	Recommended drill bit size, mm	Recommended drill bit size, inch
1	580	730	Not recommended	Not recommended	100-150	4-6
2	1400	1700	40-80	2-4	40-80	2-4
3	2900	3600	0-40	0-2	0-40	0-2

TECHNICAL DATA

EU Declaration of Conformity

OM version

(Applies to Europe only)

We, **Husqvarna AB**, SE 561 82 Huskvarna, SWEDEN, Tel. +46 36 146500 declare on our sole responsibility that the product:

Description	Drill Machine
Brand	HUSQVARNA
Type / Model	DM 230
Identification	Serial numbers dating from 2018 and onwards

complies fully with the following EU directives and regulations:

Directive/Regulation	Description
2006/42/EC	"relating to machinery"
2011/65/EU	"relating to restriction of hazardous substances"

and that harmonized standards and/or technical specifications are applied as follows;

EN ISO 12100:2010

EN 60745-1:2009

EN 60745-2-1:2007

Partille, 3 May 2018



Joakim Ed

Global R&D Director

Responsible for technical documentation

WIRING DIAGRAM

DM 230

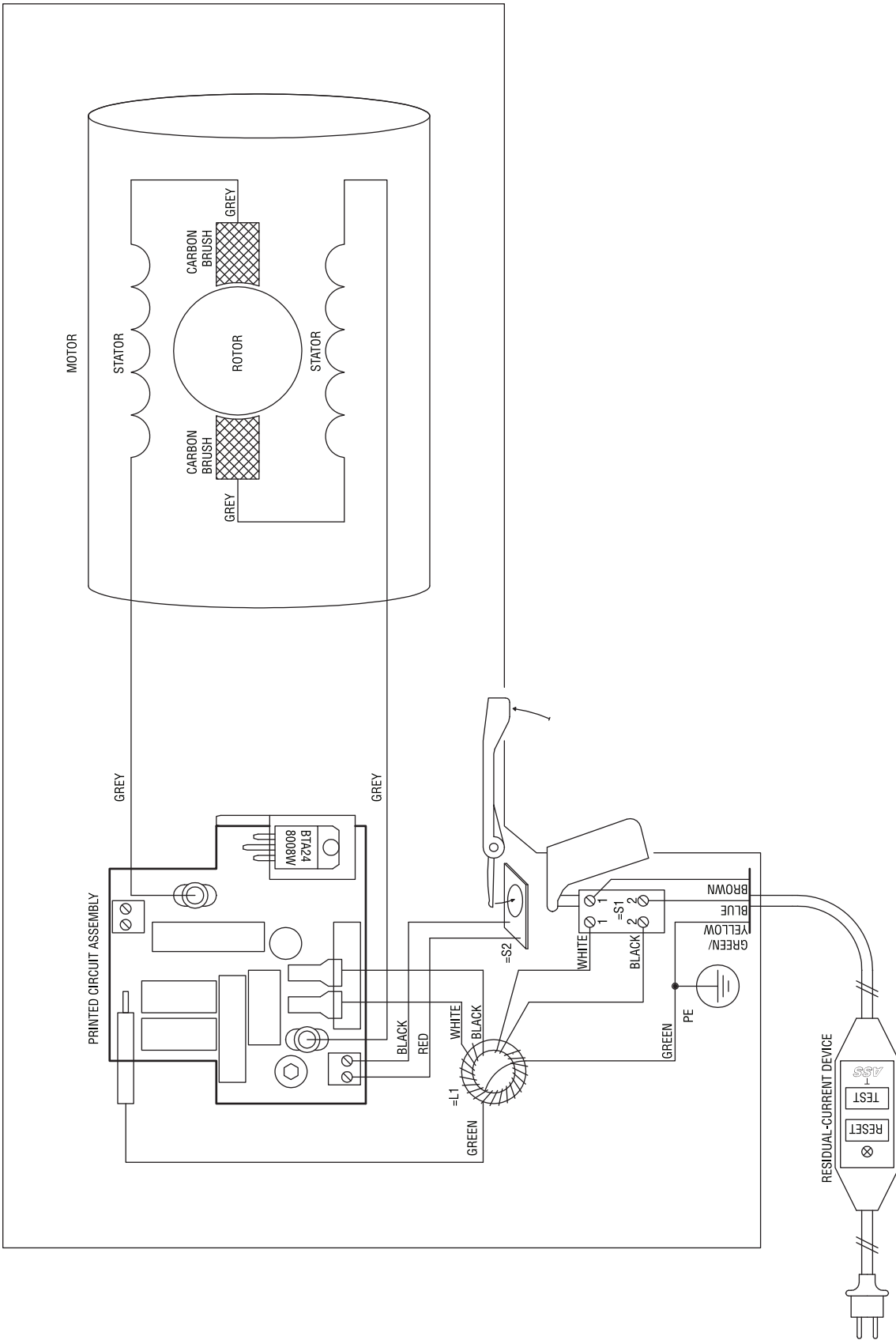



www.husqvarnacp.com

GB - Original instructions



1154251-26

2018-05-03 rev2