



US

Operator's manual

Please read the operator's manual carefully and make sure you understand the instructions before using the machine.

FR

Manuel d'utilisation

Lire attentivement et bien assimiler le manuel d'utilisation avant d'utiliser la machine.

ES

Manual de instrucciones

Lea detenidamente el manual de instrucciones y asegúrese de entender su contenido antes de utilizar la máquina.

DM 330

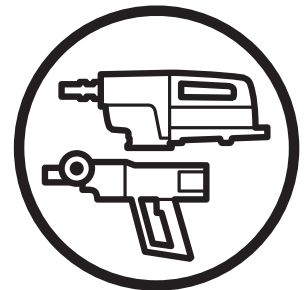

US FR ES

KEY TO SYMBOLS

Symbols on the machine:

WARNING! The machine can be a dangerous tool if used incorrectly or carelessly, which can cause serious or fatal injury to the operator or others.



Please read the operator's manual carefully and make sure you understand the instructions before using the machine.



Always wear:

- Approved protective helmet
- Approved hearing protection
- Protective goggles or a visor
- Breathing mask



Environmental marking. Symbols on the product or its packaging indicate that this product cannot be handled as domestic waste. It must instead be submitted to an appropriate recycling station for the recovery of electrical and electronic equipment.



By ensuring that this product is taken care of correctly, you can help to counteract the potential negative impact on the environment and people that can otherwise result through the incorrect waste management of this product.

For more detailed information about recycling this product, contact your municipality, your domestic waste service or the shop from where you purchased the product.

Ensure that water cannot leak into the machine when drilling in the ceiling. Use an appropriate water collector and cover the machine in plastic, but do not cover the air intakes and air outlets.



Other symbols/decals on the machine refer to special certification requirements for certain markets.

Symbols in the operator's manual:

Inspection and/or maintenance should be carried out with the motor switched off and the plug disconnected.

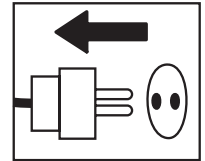

Always wear approved protective gloves.

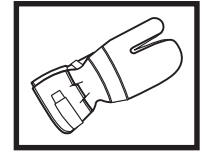

Regular cleaning is required.

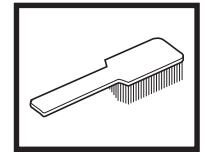

Visual check.

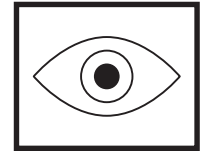

Protective goggles or a visor must be worn.



CONTENTS

Contents

KEY TO SYMBOLS

Symbols on the machine:	2
Symbols in the operator's manual:	2

CONTENTS

Contents	3
----------------	---

WHAT IS WHAT?

What is what on the drilling machine?	4
---	---

SAFETY INSTRUCTIONS

Steps before using a new drilling machine	5
Personal protective equipment	5
General safety precautions	6
General working instructions	8
Machine's safety equipment	9

PRESENTATION

DM 330	10
--------------	----

STARTING AND STOPPING

Before starting	11
Starting	11
Stopping	11

MAINTENANCE

General	12
Changing the drill bit	12
Cleaning	12
Electrical Feed	12
Repairs	14
Changing the gearbox oil	13
Replacing the carbon brushes	13
Replacing the seal retainer	14
Daily maintenance	14

TECHNICAL DATA

US WARRANTY STATEMENT

WARRANTY POLICY	16
EQUIPMENT	16

WHAT IS WHAT?

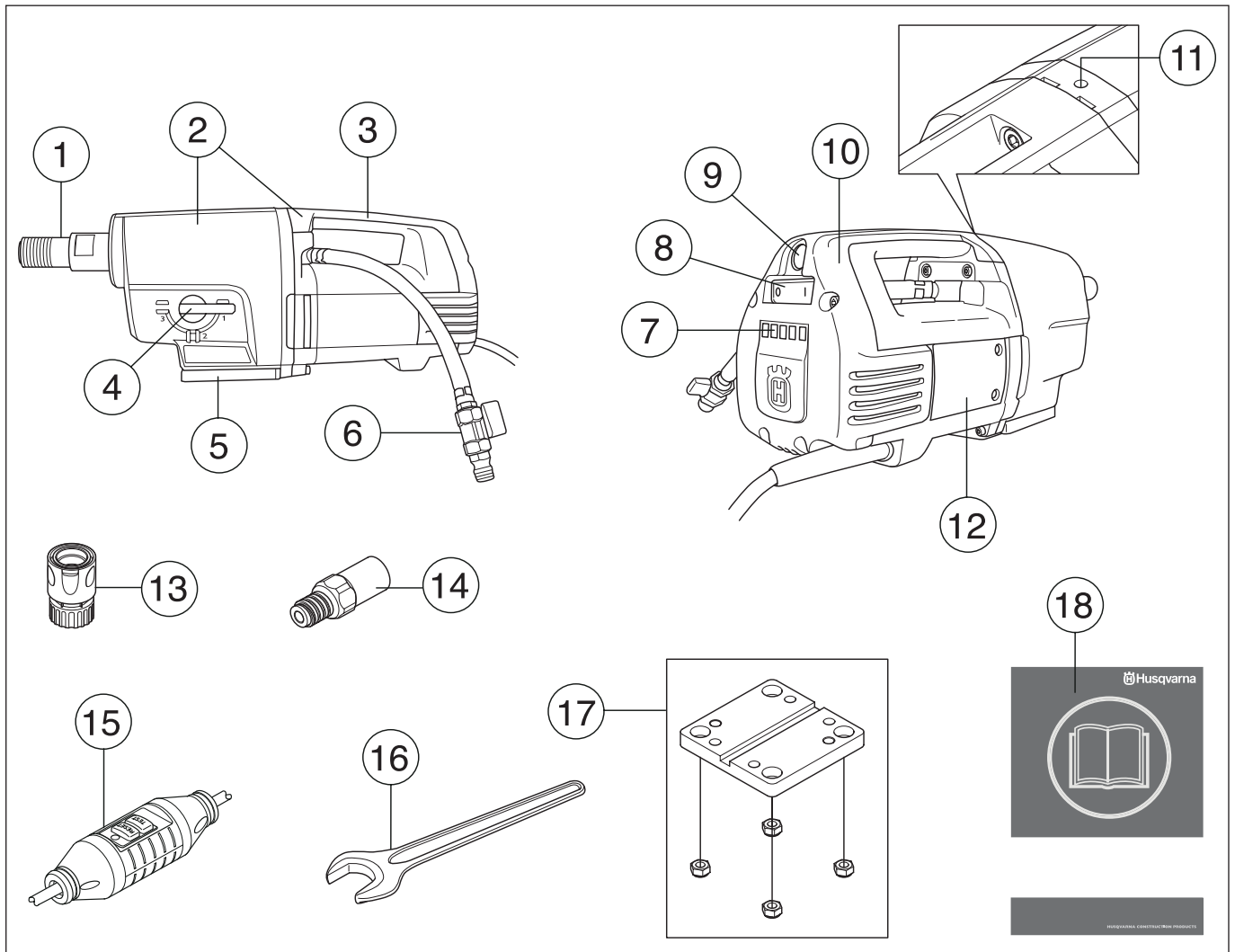

What is what on the drilling machine?

- | | |
|------------------------------------|-------------------------------------|
| 1 Drill spindle | 10 Inspection cover |
| 2 Gearbox and motor module | 11 Leakage hole |
| 3 Carrying handle | 12 Inspection hatch |
| 4 Gear knob | 13 Junction coupling (accessory) |
| 5 Quick mount, for Husqvarna stand | 14 Adapter (accessory) |
| 6 Water connector | 15 Ground fault circuit interrupter |
| 7 LEDs for indicating power output | 16 Open-ended spanner, 32 mm |
| 8 Switch | 17 Engine mount, stand |
| 9 Smartstart™ | 18 Operator's manual |

SAFETY INSTRUCTIONS

Steps before using a new drilling machine

- Do not use the drilling machine without first reading and understanding the contents of this Operator's Manual.
- DM 330 is an electric stand drill, intended for drilling holes in concrete, bricks and various stone materials.
- The machine is intended for use in industrial applications by experienced operators. Use in any other way is considered as contrary to the intended use.

Always use common sense

It is not possible to cover every conceivable situation you can face when using a drilling machine. Always exercise care and use your common sense. Avoid all situations which you consider to be beyond your capability. If you still feel uncertain about operating procedures after reading these instructions, you should consult an expert before continuing. Do not hesitate to contact your dealer or us if you have any more questions about the use of the drilling machine. We will willingly be of service and provide you with advice as well as help you to use your drilling machine both efficiently and safely.

Let your Husqvarna dealer check the drilling machine regularly and make essential adjustments and repairs.

Husqvarna Construction Products has a policy of continuous product development. Husqvarna reserves the right to modify the design and appearance of products without prior notice and without further obligation introduce design modifications.

All information and all data in the Operator's Manual were applicable at the time the Operator's Manual was sent to print.



WARNING! Under no circumstances may the design of the machine be modified without the permission of the manufacturer. Always use genuine accessories. Non-authorized modifications and/or accessories can result in serious personal injury or the death of the operator or others.



WARNING! Some dust created by power sanding, sawing, grinding, drilling, and other construction activities contains chemicals known (to the State of California) to cause cancer, birth defects or other reproductive harm. Some examples of these chemicals are:

Lead from lead-based paints.

Crystalline silica from bricks, cement and other masonry products.

Arsenic and chromium from chemically treated lumber.

Your risk from these exposures varies, depending on how often you do this type of work. To reduce your exposure to these chemicals: work in a well ventilated area, and work with approved safety equipment, such as those dust masks that are specially designed to filter out microscopic material.

Personal protective equipment



WARNING! You must use approved personal protective equipment whenever you use the machine. Personal protective equipment cannot eliminate the risk of injury but it will reduce the degree of injury if an accident does happen. Ask your dealer for help in choosing the right equipment.

- Protective helmet
- Hearing protection
- Protective goggles or a visor

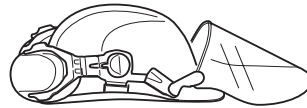

- Breathing mask

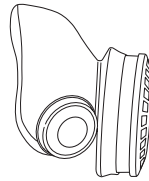

- Heavy-duty, firm grip gloves.



- Tight-fitting, heavy-duty and comfortable clothing that permits full freedom of movement.



- Boots with steel toe-caps and non-slip sole



- Always have a first aid kit nearby.



SAFETY INSTRUCTIONS

General safety precautions



WARNING! Read all safety warnings and all instructions. Failure to follow the warnings and instructions may result in electric shock, fire and/or serious injury.

Work area safety

- Keep work area clean and well lit. Cluttered or dark areas invite accidents.
- Do not operate power tools in explosive atmospheres, such as in the presence of flammable liquids, gases or dust. Power tools create sparks which may ignite the dust or fumes.
- People and animals can distract you causing you to lose control of the machine. For this reason, always remain concentrated and focused on the task.
- Do not use the machine in bad weather, such as dense fog, heavy rain, strong wind, intense cold, etc. Working in bad weather is tiring and can lead to dangerous conditions, e.g. slippery surfaces.
- Never start to work with the machine before the working area is clear and you have a firm foothold. Look out for any obstacles with unexpected movement. Ensure that no material can become loose and fall, causing injury when operating the machine.
- Always check the rear side of the surface where the drill bit will emerge when drilling right through. Secure and cordon off the area and make sure that no one can be injured or material damaged.

Electrical safety



WARNING! There is always a risk of shocks from electrically powered machines. Avoid unfavourable weather conditions and body contact with lightning conductors and metal objects. Always follow the instructions in the Operator's manual to avoid damage.



WARNING! Do not wash the machine with water, as water can enter the electrical system or the engine and cause damage to the machine or short circuit.

- The machine should be connected to an earthed outlet socket.
- Check that the mains voltage corresponds with that stated on the rating plate on the machine.
- Check that the cord and extension cord are intact and in good condition. Use an extension cord intended for outdoor use.
- Never use the machine if the cord is damaged, hand it in to an authorized service workshop for repair.
- Do not use an extension cord while it is rolled up to avoid overheating.
- Never carry the machine by means of the cord and never pull out the plug by pulling the cord.
- Keep all cords and extension cords away from water, oil and sharp edges. Make sure the cord is not pinched in doors, fences or the like. Otherwise it can cause the object to become live.
- The power tool should not be exposed to more moisture than what is provided by the water system. Do not expose the power tool to rain. Water entering a power tool will increase the risk of electric shock.
- Ensure the cord is behind you when you start to use the machine so that the cord will not be damaged.

SAFETY INSTRUCTIONS

Personal safety

- Wear personal protective equipment. See instructions under the heading Personal protective equipment.
- Never use the machine if you are tired, if you have drunk alcohol, or if you are taking medication that could affect your vision, your judgement or your co-ordination.
- Prevent unintentional starting. Ensure the switch is in the OFF-position before connecting to power source. Carrying power tools with your finger on the switch or energising power tools that have the switch on invites accidents.
- Remove any adjusting key or wrench before turning the power tool on. A wrench or a key left attached to a rotating part of the power tool may result in personal injury.
- Never allow anyone else to use the machine without first ensuring that they have understood the contents of the operator's manual.
- Be careful as clothing, long hair, and jewellery can get caught in moving parts.
- Remain at a distance from the drill bit when the motor is running.
- Make sure that no pipes or electrical cables are routed in the area to be drilled.
- Never leave the machine unsupervised with the motor running.
- Always unplug the machine during longer work breaks.
- Never work alone, always ensure there is another person close at hand. Apart from being able to receive help to assemble the machine, you can also get help if an accident should occur.

Use and care

- Never use a machine that is faulty. Carry out the checks, maintenance and service instructions described in this manual. Some maintenance and service measures must be carried out by trained and qualified specialists. See instructions under the heading Maintenance.
- Inspection and/or maintenance should be carried out with the motor switched off and the plug disconnected.
- Do not use the power tool if the switch does not turn it on and off. Any power tool that cannot be controlled with the switch is dangerous and must be repaired.
- Never use a machine that has been modified in any way from its original specification.
- Do not overload the machine. Overloading can damage the machine.
- Keep tools sharp and clean in order to enable safer work.
- Keep all parts in good working order and ensure that all fixtures are properly tightened.

Transport and storage

- Do not store or transport the drilling machine with the drill bit fitted in order to protect your drilling machine and drill bits from damage.
- Store the drilling machine in a lockable area so that it is out of reach of children and unauthorised persons.
- Store the drilling machine and stand in dry and frost free conditions.

SAFETY INSTRUCTIONS

General working instructions



WARNING! This section takes up the basic safety precautions for working with the drilling machine. This information is never a substitute for professional skills and experience. If you encounter a situation where you are uncertain how to proceed you should ask an expert. Contact your dealer, service agent or an experienced drilling machine user. Do not attempt any task that you feel unsure of!

- The machine has a very high torque. This demands good concentration during work, as serious personal injuries can occur if the drill bit suddenly jams.
- Keep your hands at a safe distance from the drill spindle and drill bit when the machine is running.
- Keep an eye open for oil or water leakage. If water or oil trickles out from the leakage hole on the top of the pinion neck, the seals must be replaced.

Stand drilling

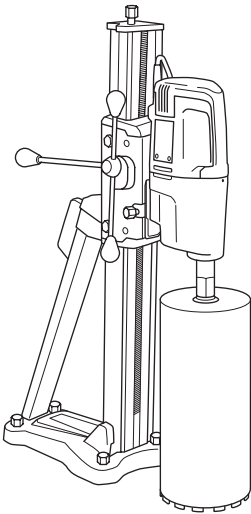

- The machine is intended for stand mounted drilling.
- We recommend the stand Husqvarna DS 450 for use with the drill engine.
- Make sure that the stand is secured correctly.
- Make sure that the drilling machine is secured correctly in the stand.

Drilling outdoors

- Always use extension cables that are approved for outdoor use.

Drilling in ceilings and the like

- Use a water collector to avoid water penetrating into the machine. The machine must be covered with plastic or the like in order to prevent water penetrating into the machine, but do not cover the air intakes and air outlets.

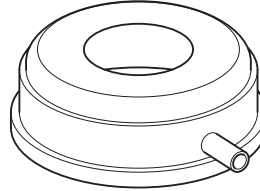

IMPORTANT! The air intake must not be covered.

SAFETY INSTRUCTIONS

Machine's safety equipment



This section describes the machine's safety equipment, its purpose, and how checks and maintenance should be carried out to ensure that it operates correctly. See the "What is what?" section to locate where this equipment is positioned on your machine.



WARNING! Never use a machine that has faulty safety equipment!

IMPORTANT! All servicing and repair work on the machine requires special training. This is especially true of the machine's safety equipment. If your machine fails any of the checks described below you must contact your service agent. When you buy any of our products we guarantee the availability of professional repairs and service. If the retailer who sells your machine is not a servicing dealer, ask him for the address of your nearest service agent.

Switch

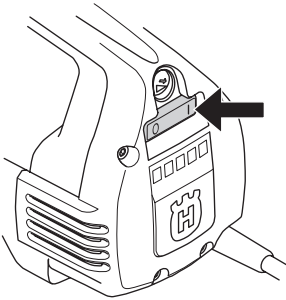

The power switch should be used to start and stop the machine.

Checking the power switch

- Start the machine by switching on the on-off switch.
- Switch the on-off switch off to stop the machine.
- A defective power switch should be replaced by an authorized service workshop.

Ground fault circuit interrupter

Ground fault circuit interrupters are for protection in case an electrical fault should occur.

The LED indicates that the ground fault circuit interrupter is on and that the machine can be switched on. If the LED is not on, push the RESET button (green).



Check the ground fault circuit interrupter

- Connect the machine to the socket. Push the RESET button (green) and the red LED lights up.



- Start the machine by pressing the power switch.
- Push the TEST button (blue).



- The ground fault circuit interrupter should trip and the machine switch off instantly. If not, contact your dealer.

PRESENTATION

DM 330

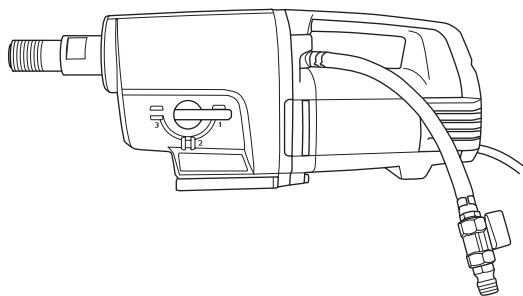

It is our wish that you will be satisfied with your product and that it will be your companion for a long time. Think of this operator's manual as a valuable document. By following its' content (using, service, maintenance etc) the life span and the second-hand value of the machine can be extended. If you ever lend or sell this machine, make sure that the borrower or buyer gets the operator's manual, so they will also know how to properly maintain and use it.

A purchase of one of our products gives you access to professional help with repairs and services. If the retailer who sells your machine is not one of our authorised dealers, ask him for the address of your nearest service workshop.

Husqvarna Construction Products has a policy of continuous product development. Husqvarna reserves the right to modify the design and appearance of products without prior notice and without further obligation introduce design modifications.

- DM 330 is an electric stand drill, intended for drilling holes in concrete, bricks and various stone materials.
- The drilling machine has a modular design and is easy to assemble.
- The machine is equipped with a water connection which can be rotated 180 degrees to facilitate work.
- DM 330 has three speed ranges for drill sizes up to 350 mm on the low speed version and 250 mm on the high speed version.
- The machine has a water cooled gearbox with a pipe that runs through the spindle.
- The machine is equipped with LEDs which indicate the power output. This way you can always get maximum power output without damaging the machine.

The drilling machine is equipped with Softstart™, Smartstart™, Elgard™ and speed control.

Softstart™

Softstart™ is an electronic current limiter which provides a softer start. Maximum speed is reached about three seconds after the machine is turned on.

Smartstart™

If the Smartstart™ button is pressed in the speed is reduced. In Smartstart™ mode the machine has less power until the button is pressed in again. These functions are of great use for creating a pilot hole for drilling.

Elgard™

Elgard™ is an electronic overload protection. It considers factors such as rated input voltage and ambient temperature. This way you can always get maximum power output without damaging the machine.

If the motor is overloaded, the overload protection pulses the motor. Reduce the load and the motor returns to its normal speed. The overload protection disconnects the power, if the machine is subjected to heavy loads or if the drill bit jams. Reset the machine by switching it off and then on again. If the drill bit jams, the mechanical slip clutch protects the gearbox before the overload protection disconnects the power.

Speed control

The speed control function provides the machine with a limited idling speed. This provides a more effective cooling of the machine at idle speed.

Ergonomics

The carrying handle makes it easy to carry/transport the machine and facilitates mounting it on the stand.

STARTING AND STOPPING

Before starting



WARNING! Note the following before starting:

The machine should be connected to an earthed outlet socket.

Check that the mains voltage corresponds with that stated on the rating plate on the machine.

Ensure you stand firmly. Keep people and animals well away from the working area.

Make sure that:

- The switch is undamaged. If not, the switch must be replaced by an authorised repairman.
- Cooling air vents are not blocked.
- The machine and its equipment are correctly installed.
- The stand is properly fixed and that the drill is properly mounted on the stand.
- The drill is secured properly.
- Water cooling is connected to the machine. Use suitable drill bits depending on whether water or dry drilling is being performed. In the event of uncertainty contact your dealer, your service workshop or an experienced operator.
- Prevent unintentional starting. Ensure the switch is in the OFF-position before connecting to power source.

Starting

IMPORTANT! Changing gear may only be done when the machine is switched off. Otherwise there is a risk of damaging the gearbox.

- 1 Set the working speed by turning the drill spindle and at the same time move the gear knob to the required position.

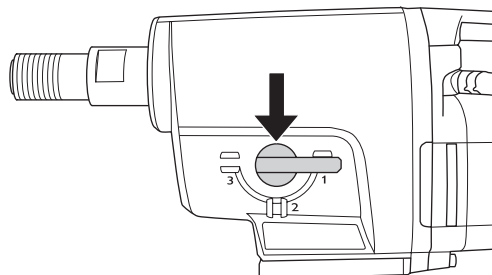

- 2 Turn on the water cooling.
- 3 Start the machine by switching on the on-off switch.

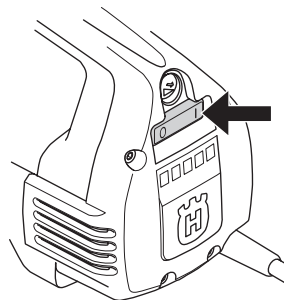

Also press, if desired, the Smartstart™ button.

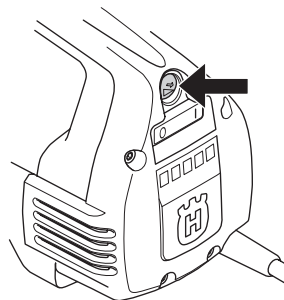

Stopping



WARNING! The drill bit continues to rotate for a while after the motor has been switched off.

Do not stop the drill bit with your hands. Personal injuries can occur.

Switch the on-off switch off to stop the machine.

Cooling

Run the machine unloaded for a minute or two to cool the motor.

MAINTENANCE

General



IMPORTANT! Inspection and/or maintenance should be carried out with the motor switched off and the plug disconnected.

The lifetime of your machine can be extended considerably if it is used, cared for and maintained in the proper manner.

Changing the drill bit



- 1 Pull out the plug.
- 2 Get:
 - The new drill bit.
 - Open-ended spanners, size 24 mm and 32 mm.
 - Water-resistant grease.
- 3 Remove the old drill bit using the open-ended spanners.
- 4 Apply water-resistant grease to the thread of the new drill bit.
- 5 Attach the drill bit using the open-ended spanners.

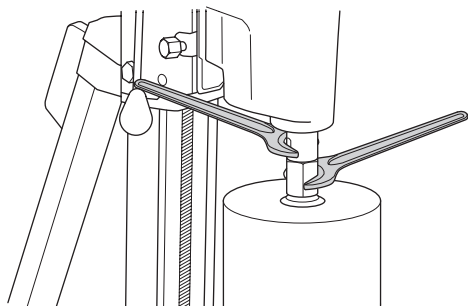

Before the machine is started, carefully check that the new bit is firmly attached.

Cleaning



- Keep the machine and drill bit clean in order for drilling to be carried out safely.

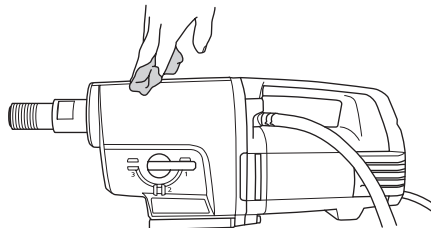

- Keep the handle dry and free of grease and oil.
- In order for the machine to always be cooled sufficiently the cooling air openings must be kept clear and clean.

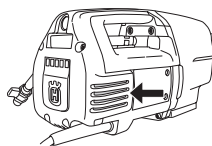

- Use compressed air to periodically clean the motor. Remove the inspection cover and clean the cover.

Electrical Feed



WARNING! Never use damaged cables that can cause serious, even fatal, personal injuries.

Check that the cord and extension cord are intact and in good condition. Never use the machine if the cord is damaged, hand it in to an authorized service workshop for repair.

MAINTENANCE

Changing the gearbox oil



Contact your dealer to get the right oil.

The oil in the gearbox must be changed after every 400 hours of operation. Do as follows:

- 1 Get:
 - New oil, STATOIL SYNTOL 75W-90 or other similar transmission oil.
 - A container for the old oil.
- 2 Secure the machine with drill spindle downwards in a vice or the like.

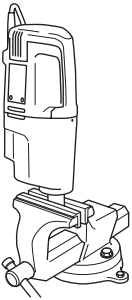

- 3 Unscrew the four screws holding the motor - gearbox modules together.

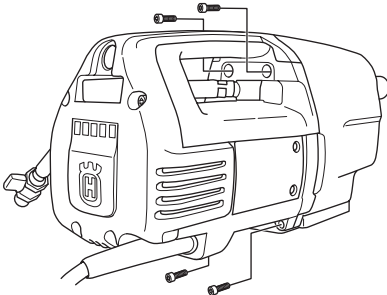

- 4 Carefully disassemble the machine.
- 5 Empty the gearbox oil into the container.
- 6 If necessary contact your dealer to clean the gearbox.
- 7 Pour the new oil into the gearbox, about 0.5 litres.

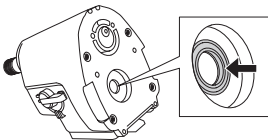

- 8 Check that the sealing lip on the radial seal is intact.
- 9 Reassemble the machine and screw in the four screws. Be careful when assembling so as not to damage the radial seal.

Replacing the carbon brushes



The carbon brushes must be removed and checked regularly. Weekly if the machine is used daily or at longer intervals if the machine is used more seldom. The area of wear should be even and undamaged.

Both carbon brushes must always be replaced as a pair, but one at a time. Do as follows:

- 1 Remove the 5 screws from the inspection cover. Use a chisel in the break tracks to easier remove the inspection cover.

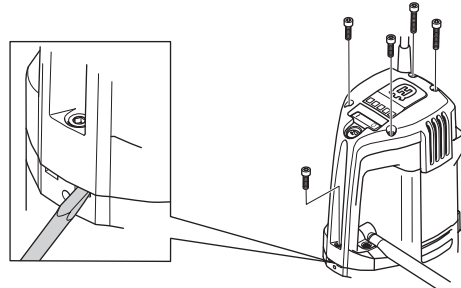

- 2 Lift the carbon brush holder spring to one side (A).

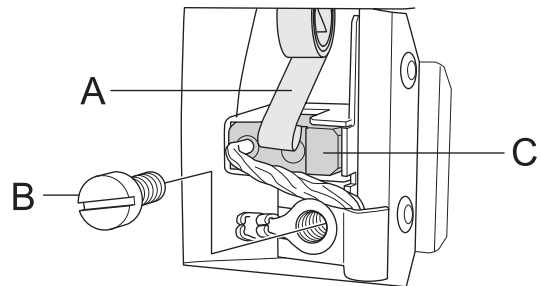

- 3 Loosen the screw (B).
- 4 Pull out the carbon brush connector.
- 5 Pull the carbon brush out from the holder (C).
- 6 Clean the brush holder with compressed air or a brush. Replace the brush if worn.
- 7 Fit the new carbon brush. Make sure that the side with the copper wire is facing the gear box and that the carbon brush slides easily in the brush retainer. If the carbon brush is fitted in the wrong direction it can get jammed.
- 8 Put the brush holder spring back into place.
- 9 Insert the carbon brush connection under the screw.
- 10 Repeat the procedure with the other carbon brush.
- 11 Guide the inspection cover into the handle's tracks. Begin with the screw at the very bottom of the handle and unscrew the inspection cover's five screws.
- 12 Let the machine idle for 10 minutes to run in the new carbon brushes.

MAINTENANCE

Replacing the seal retainer

If there is oil or water coming out of the leakage hole the seal retainer must be replaced.

- 1 Loosen the two screws for the water module.

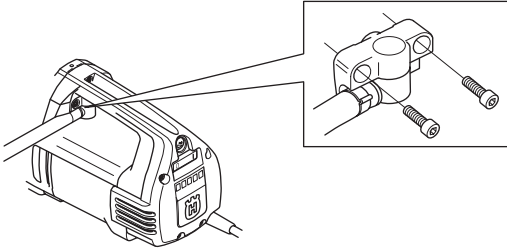

- 2 Use two flathead screwdrivers to carefully prize open the seal retainer.
- 3 Carefully push in the new seal retainer and screw the water module back on.

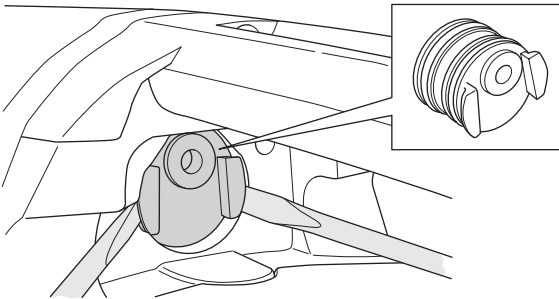

Daily maintenance



- 1 Check that nuts and screws are tight.
- 2 Check that the power switch unit works smoothly.
- 3 Clean the outside of the machine.
- 4 Check and clean the cooling air openings.
- 5 Check that the cord and extension cord are intact and in good condition.

Repairs

Important All types of repairs may only be carried out by authorised repairmen. This is so that the operators are not exposed to great risks.

TECHNICAL DATA

DM 330

Electric motor	Single-phase
Rated voltage, V	230/120

Rated output, W

230V	2700W
120V	2400W

Rated current, A

230V	13A
120V	20A

Weight, kg	13
------------	----

Max. diameter drill bit, mm/inch

Low speed	350/14
High speed	250/10

Spindle thread	G 1 1/4"
----------------	----------

Water connector	G 1/4"
-----------------	--------

Low speed

Gear housing	Drill bit speed with load, rpm	Drill bit load without load, rpm	Recommended drill bit size, mm	Recommended drill bit size, inch
1	250	310	200-350	8-14
2	550	690	100-200	4-8
3	950	1190	50-100	2-4

High speed

Gear housing	Drill bit speed with load, rpm	Drill bit load without load, rpm	Recommended drill bit size, mm	Recommended drill bit size, inch
1	360	450	150-250	6-10
2	800	1000	75-150	3-6
3	1380	1730	25-75	1-3

US WARRANTY STATEMENT

WARRANTY POLICY

All warranty claims will be determined after inspection at a designated facility. A Returned Goods Authorization is required for all warranty claims. Contact Husqvarna Customer Service Department at 800-845-1312 for an RGA. The customer must prepay the freight and absorb any labor expense required to return or replace a product submitted for warranty consideration. Husqvarna will pay return shipping expenses for repaired or approved replacement products.

EQUIPMENT

Equipment manufactured by Husqvarna is warranted to be free from manufacturing defects in normal service for a period of two (2) years from date of purchase by the original consumer purchaser. **Component manufacturers offer separate warranty periods. Call Technical Services at 800-288-5040 for complete information.**

Our obligation under this warranty is expressly limited to the replacement or repair at Husqvarna Construction Products North America, Olathe, Kansas 66061, or at a service facility designated by us, of such part or parts as inspection shall disclose to have been defective.

This warranty does not apply to defects caused by damage, unreasonable use, faulty repairs made by others than an approved Husqvarna servicing dealer, or defects caused by failure to provide reasonable maintenance, while in the possession of the consumer. Further, the warranty is void if the product, or any of its components, are altered or modified by the consumer purchaser, or if the product is used in an inappropriate manner or with tools not recommended by the manufacturer.

Exceptions: Drill motors - 3 months, Wall saws - 1 year, Power cutters - 3 months, DM230 - 1 year, DM225 - 3 months, Gyro systems - 1 year, CD40 system - 1 year, DS160 C - 1 year, Smart box - 1 year, CS2515 - 1 year, PP455 E - 1 year, PP345 E - 1 year, HP40 - 1 year.

Wear items: Filters, spark plugs, bearings*, belts, wheels** and wear pads.

*Except IntelliSeal™ system. **Except delamination.



www.husqvarnacp.com

1151161-95

2008-06-24

